

Onshore Rig Families

OILMAN

Oilman has been dedicating himself to serve drilling contractors since its establishment in year 1999 with world-class products & professional Engineer services at competitive cost. All products supplied are machined by China both API and ISO certified workshop as per Western designs.

Tubular Handling tools: Varco/BJ, Baash-Ross, Cavins, Joy.
 Solid Control Equipments: Derrick, Swaco, Brandt, Mission, Harrisbrg
 Mud pump: C. Emsco, Gardner Denver
 Mud valve: Cameron, Demco, and WKM
 BOP Products: Cameron and Shaffer and Koomey

Rig Engineering and Rig-up Commission
 Rig Operation Engineers services and consumables local stoks & supply.
 Drilling equipments and tools R & D and supply.

DRILLING, WORKOVER EQUIPMENTS AND TOOLS

S/N PRODUCTS

Rigs & Accessories

RIG01 Land Drilling Rig
 RIG02 Self-propelled Drilling Rig
 RIG03 Workover Rig
 RIG04 Rotary Table
 RIG05 Elevator Link
 RIG06 Swivel
 RIG07 Hook
 RIG08 Traveling Block
 RIG09 Block-Hook
 RIG10 Drilling Line

MP Mud pump & Fluid End Parts

MP01 Triplex Single Acting Pump
 MP02 Light duty plunger mud pum

SC Solid Control Equipments

SC01 Shale Shaker
 SC02 Desander
 SC03 Desilter
 SC04 Centrifuge
 SC05 Centrifugal pump

HT Handling Tools

HT01 Slips
 HT02 Elevator
 HT03 Safety Clamp
 HT04 Bushing
 HT05 Casing Spider
 HT06 Tubing Spider
 HT07 Casing Elevator /Spider
 HT08 Manual tong
 HT09 Power tong

BOP Blowout Preventing Equipments

BOP01 Annular BOP
 BOP02 Ram BOP
 BOP03 Accumulator & Control panel
 BOP04 Choke and Kill manifold
 BOP05 Co-Flex steel Hose
 BOP06 Test pump

DHT Down hole tools

DHT01 Kelly & Kelly Cock
 DHT02 Drill Collar (DC)
 DHT03 HW Drill pipe (HWDP)
 DHT04 Stabilizers
 DHT05 Down Hole motor (DHM)
 DHT06 Hole opener

S/N PRODUCTS

RIG11 Top Drive System
 RIG12 Rig motor
 RIG13 Drilling Instrumentations
 RIG14 Rig lighting system
 RIG15 Rig Roller Chain
 RIG16 Rig Air Compressor
 RIG17 Diesel Engine
 RIG18 Rotary Hose
 RIG19 Survey Winch

MP03 Accessories to mud pump
 MP04 Expendables and Fluid end parts

SC06 Shearing Pump
 SC07 Mixing pump
 SC08 Agitator
 SC09 Mud Tank

HT10 Iron Roughneck
 HT11 Hydraulic Torque wrench
 HT12 Air winch
 HT13 Hydraulic winch
 HT14 Air Safety Spinning Wrench
 HT15 Hydraulic Safety Spinning Wrench
 HT16 Hydraulic cathead
 HT17 Kelly Spinner

BOP07 Choke valves and control panel
 BOP08 Gate valve
 BOP09 Inside BOP
 BOP10 Gas-liquid separator
 BOP11 Degasser
 BOP12 Mud pit monitoring and alarming system

DHT07 Reamer
 DHT08 Drilling Jar
 DHT09 Shock Absorber
 DHT10 Floating valve
 DHT11 X-over Subs
 DHT12 Core Barrel

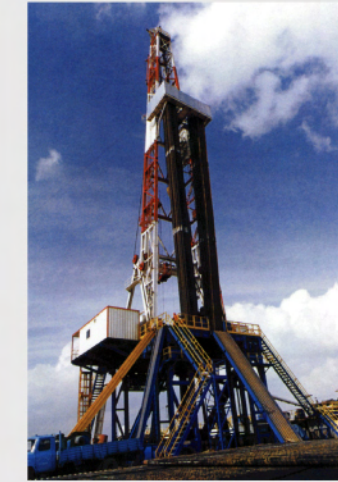

Order code	Model	Type	Horse Power (HP)	Max. Hook Load (tons)	Drilling depth by 4 1/2" DP		Drilling Depth by 5" DP	
					ft	mtr	ft	Mtr
RIG0101	E1000	AC-SCR-AC /DC	1,000	250	13,120	4,000	10,496	3,200
RIG0102	E1500	AC-SCR-AC /DC	1,500	350	16,400	5,000	14,760	4,500
RIG0103	E2000	AC-SCR-AC /DC	2,000	500	22,960	7,000	19,680	6,000
RIG0201	SPD350	Self-propelled	350	90	3,280	1,000	--	--
RIG0202	SPD650	Self-propelled	650	150	6,562	2,000	--	--
RIG0203	SPD1000	Self-propelled	1,000	180	9,842	3,000	--	--



Order code	Model	Type	Horse Power (HP)	Max. Hook Load (tons)	Workover depth by 3 1/2" DP		Workover depth by 2 1/2" TBG	
					ft	mtr	ft	Mtr
RIG0301	SPW350	Self-propelled	350	90	10,498	3,200	--	--
RIG0302	SPW650	Self-propelled	650	150	16,400	5,000	24,606	7,500
RIG0303	SPW1000	Self-propelled	1,000	180	21,325	6,500	27,886	8,500
RIG0304	SPW220	Self-propelled	220	90	--	--	13,120	4,000
RIG0305	SPW525	Self-propelled	525	180	18,040	5,500	--	--

Notes:

- 1) Self-propelled workover rig is designed for both double Drum and single Drum.
- 2) The Diesel Engine could be CAT, or Detroit while Transmission is Allison.

WARRANTY

OILMAN warrants its products to be free from defects in materials and /or workmanship under normal use and services for a period of one (1) year from the date of shipment. The liability for any defects shall be limited to the repair or replacement of such products, or, at the option of OILMAN the refunding of purchase prices. This Warranty is expressly in lieu of all other warranties and representations, expressed or implied, and all other obligations or liabilities on the part of OILMAN, which shall not be liable for consequential damages for any breach of warranty. Any controversy or dispute arising out of the sale of OILMAN products shall be determined in accordance with Laws and /or regulations of P. R. Of China

REMARKS

All Trademarks, trade names & parts numbers are for identification purposes only

ROTARY TABLE (RIG04)

Main features

- Both C. Emsco and National Oilwell designs are available.
- The pinion and gear are made of alloy steel.
- The extension and its keyway of the pinion shaft all meet API Spec.
- The master Bushing is made of steel casting with API Standard square Kelly or Hexagonal Kelly as per Varco designs.
- Mechanical and electrical independent table drives can be furnished.

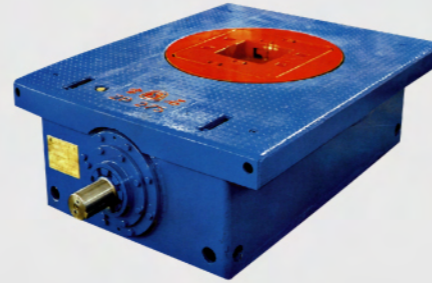

Order Code	RIG0401	RIG0402	RIG0403	RIG0404	RIG0405
Model	RT175	RT205	RT275	RT375	RT495
Equivalent	T-1750-44	T-2050	T-2750	T-3750	T-4950
Max. Opening (in)	17.5	20.5	27.5	37.5	49.5
Distance from table axis to center inner row of sprocket teeth (in)	44	53.25	53.25	53.25	65
Max. Working Torque (lb-ft)	10,132	16,646	20,265	23,883	26,778
Max. Speed (RPM)	300	300	300	300	300
Gear Ratio	3.58	3.22	3.67	3.56	3.93

ELEVATOR LINK (RIG05)

Weldless links are forged from a single piece of high-grade steel to provide maximum tensile strength. More weight and plus-diameter" in critical areas make these links extra strong. Short upper eye design means better balance and easier elevator handling, while reducing wear of the eye section against the swivel bail or body.

Size	Rated Load Capacity	Size	Rated Load Capacity
Inch	Tons	Inch	Tons
1 1/2" x 47	40	2 3/4 x 150	350
1 1/2 x 48	50	2 3/4 x 168	350
1 3/4 x 59	75	2 3/4 x 180	350
1 3/4 x 36	150	2 3/4 x 192	350
1 3/4 x 48	150	2 3/4 x 216	350
1 3/4 x 60	150	2 3/4 x 240	350
1 3/4 x 72	150	2 3/4 x 290	350
1 3/4 x 84	150	2 3/4 x 480	350
2 1/4 x 60	250	3 1/2 x 72	500
2 1/4 x 72	250	3 1/2 x 96	500
2 1/4 x 84	250	3 1/2 x 108	500
2 1/4 x 96	250	3 1/2 x 120	500
2 1/4 x 108	250	3 1/2 x 132	500
2 1/4 x 132	250	3 1/2 x 144	500
2 1/4 x 168	250	3 1/2 x 160	500
2 3/4 x 60	350	3 1/2 x 168	500
2 3/4 x 72	350	3 1/2 x 180	500
2 3/4 x 84	350	3 1/2 x 192	500
2 3/4 x 96	350	3 1/2 x 216	500
2 3/4 x 108	350	3 1/2 x 240	500
2 3/4 x 120	350	3 1/2 x 264	500
2 3/4 x 132	350	3 1/2 x 360	500
2 3/4 x 144	350		



SW Swivel (RIG06)

Features

- The standard bails and alloy steel sub with double-pin ends
- The wash pipe and packing assembly are cartridge type and can be replaced on the floor without disconnecting the rotary hose and/or gooseneck.
- The gooseneck is provided with an outlet for wire line logging.
- Offer 4" hose connector conforms to API spec.
- Swivels conform to API Spec 8A and are granted to use API monogram.



HK HOOK (RIG07)

Features

- Equipped with a Hydraulic snubber assembly to protect tools joints when making up /breaking out connection.
- Equipped with the reliable safety devices on the hook.
- The high stress parts of every hook are subjected to non-destructive testing.
- The Hooks conform to API Specifications 8A and API monogram can be used.

Model	SW135	SW170	SW225	SW450	SW585
S/N	RIG0601	RIG0602	RIG0603	RIG0604	RIG0605
Max. Static Load rating (ton)	135	170	225	450	585
Max. Rotating Speed (rpm)	300	300	300	300	300
Max. Working Pressure (PSI)	5000	5000	5000	5000	5000
Hook Clearance over Gooseneck (in)	19 1/2		21 1/4	21 19/32	23
Stem (inch)	2 1/2	2 1/2	3	3	3
Gooseneck Thread Reg	4 1/2" Reg. LH	4 1/2" Reg. LH	6 5/8" Reg. LH	7 5/8" Reg. LH	7 5/8" Reg. LH
Stem Thread (lower end)	6 5/8" Reg. LH	6 5/8" Reg. LH	6 5/8" Reg. LH	6 5/8" Reg. LH	6 5/8" Reg. LH

HOOK (RIG07)

Model	HK135	HK170	HK225	HK315	HK450	HK585
S/N	RIG0701	RIG0702	RIG0703	RIG0704	RIG0705	RIG0706
Max. Hook Load (ton)	135	170	225	315	450	585
Major Hook opening (mm)	165	180	190	220	220	238
Spring travel (mm)	180	180	180	200	200	200
Width Overall (mm)	720	750	780	890	890	930
Length (mm)	2200	2450	2548	2960	2960	3156
Weight (kg)	1910	2020	2180	3410	3496	3900



Traveling Block (RIG08) TB Series

FEATURES

- The wire line is kept taut when hoisting or lowering down the unload Block.
- The Sheave grooves are hardened by medium frequency induction to provide extended services life.
- Equipped with double-row conical roller bearings and each bearing are individually lubricated.
- The sheaves and bearing are interchangeable with those of corresponding crown block.
- The traveling blocks conform to API Specification 8A and API monogram can be used.



Hook Block (RIG09) HB Series

FEATURES

- Combination of traveling block and hook together reduces overall length and can help satisfy the requirements of operating top drive.
- The Hook blocks conform to API Spec 8A and API Monogram can be used.

Model	TB135	TB170	TB225	TB225	TB450	TB585
S/N	RIG0801	RIG0802	RIG0803	RIG0803	RIG0805	RIG0806
Max. Hook load (ton)	135	170	225	225	450	585
OD of Sheaves (in)	36	36	44	44	60	60
No of Sheaves	4	5	5	5	6	7
Size of wire rope (in)	1	1 1/8	1 1/4	1 1/4	1 1/2	1 5/8

HOOK BLOCK (RIG09)

Model	HB90	HB135	HB170	HB225	HB450
S/N	RIG0901	RIG0902	RIG0903	RIG0904	RIG0905
Max. Hook Load ton	90	135	170	225	450
OD of Sheave (in)	30	36	36	44	60
No of Sheave	4	4	5	5	6
Size of Wire Rope (in)	1	1	1 1/8	1 1/4	1 1/2
Major Hook opening mm	155	165	180	190	220
Major Hook Dia mm	116	140	150		180
Associate Hook Dia mm	80	90	90		120
Spring Travel mm		170	140	180	

DRILLING LINE API 9A (RIG10)

The 6 x 19 classification of wire ropes includes standard 6 strands, round strand ropes with 16 through 26 wires per strand. The 6 x 36 classification of wire ropes includes standard 6 strands, round strand ropes with 27 through 49 wires per strand. Although their operating characteristics vary, all have the same weight per foot and the same minimum breaking force, size for size.

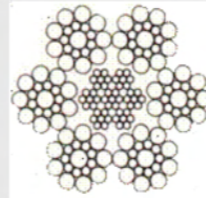

Dia		Met area	Approx. weight	Outer rope	Min Breaking Load (KN)		
Inch	Mm	Mm ²	Kg/m	Mm	IPS	EIPS	EEIPS
9/16	14.5	100.5	0.88	1.15	129	149	165
1	26.0	323.0	2.75	2.07	399	460	506
1 1/8	29.0	401.8	3.48	2.31	503	678	636
1 3/8	35.0	585.3	5.21	2.78	743	854	
1 1/2	38.0	689.9	6.19	3.02	880	1010	
1 5/8	42.0	842.8	7.26	3.34	1020		

Features:

- Power swivel is driven by two AC Motor which driven by Variable Frequency Driving (VFD) system.
- The system is equipped with transition hoisting rings to arrange wire rope in both order and disorder on the existing traveling blocks.
- Tubular handling system is equipped with annular back-up tong and such back-up tong and inside BOP will not rotate along with elevator link.

Model	TDS-500
S/N	RIG11
Rated Drilling depth by 4 1/2" DP (ft)	22960
Rated Load KN (ton)	4500 (450)
Drilling Torque lb-ft (KN.m)	36,900 (50)
Rated Horse Power HP	400 x 2
Motor	AC type, forced air cooling
Rotating Speed RPM	0-12
Max. Break out Torque lb-ft (KN.m)	55,350 (75)
Pipe Range for Back-up tong (in)	3 1/2"~5 1/2"
Upper IBOP	6 5/8" Reg Box and Pin, 10000 PSI
Lower IBOP	6 5/8" Reg Box and pin, 10000 PSI

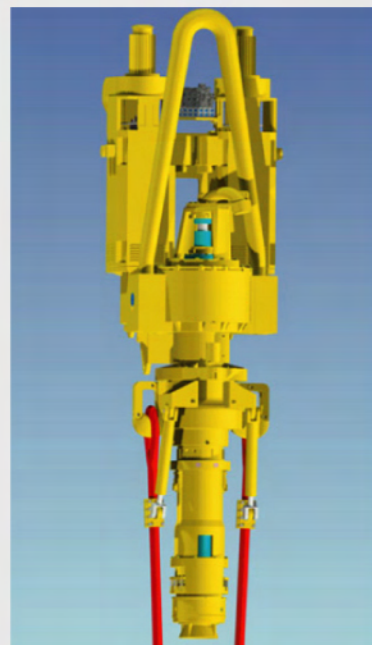

RIG MOTOR (RIG12)

The motors are made as per GE designs for drilling rigs operation with two series. One is the DC motor with separate excitation and series excitation; the other is the asynchronous (AC) motor with frequency control of motor speed. Its rated power can be from 220KW to 900KW.



YJ13 And YJ13A Variable Frequency Speed Regulating Asynchronous Motor
Used as mud pump, rotary Table, and Drawworks motor
Rated Horse Power: 1100 HP, 550 V, 1040A, 660 RPM, 33.5 HZ

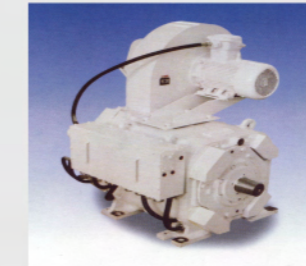

YJ14 And YJ14A Variable Frequency Speed Regulating Asynchronous Motor
Used as Mud pump, Rotary Table and Drawworks motor
Rated Horse Power: 550 HP, 550 V, 582 A, 660RPM, 33.4 HZ



YJ19, YJ19A AND YJ19B Variable Frequency Speed Regulating Asynchronous Motor
Used Mud pump, Rotary Table and Drawworks motor
Rated Horse Power: 550 HP, 600 V, 517A, 660 RPM, 33.5HZ

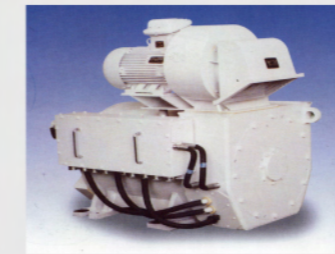

YJ21 Variable Frequency Speed Regulating Asynchronous Motor
Used Mud pump, Rotary Table and Drawworks motor
Rated Horse Power: 1100 HP, 660 V, 850 A, 800 RPM, 40.5 HZ



YJ23 Variable Frequency Speed Regulating Asynchronous Motor
Used as Mud pump, Rotary Table and Drawworks motor
Rated Horse Power: 825 HP, 600 V, 714 A, 660 RPM. 33.5 HZ



YJ27 Asynchronous Traction Motor
Used as Drawworks motor
Rated Horse Power: 320 HP, 380 V, 444 A, 686 RPM.

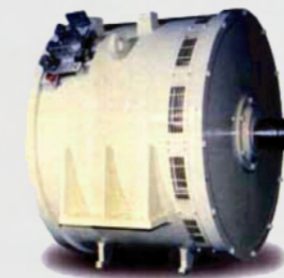

YZ08 And YZ08A DC Motor
Used as mud pump, Rotary Table, and Drawworks motor
Rated Horse Power: 1100 HP, 750 V, 1150 A, 970 RPM,



YZ08F DC Motor
Used as mud pump, Rotary Table, and Drawworks motor
Rated Horse Power: 1100 HP, 750 V, 1150 A, 1060 RPM

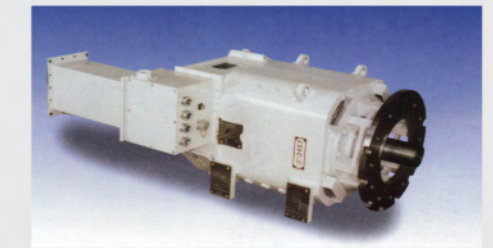

YZ10 DC Motor
Used as mud pump, Rotary Table, and Drawworks motor
Rated Horse Power: 1100 HP, 750 V, 1150 A, 1060 RPM

DRILLING INSTRUMENT (RIG13)

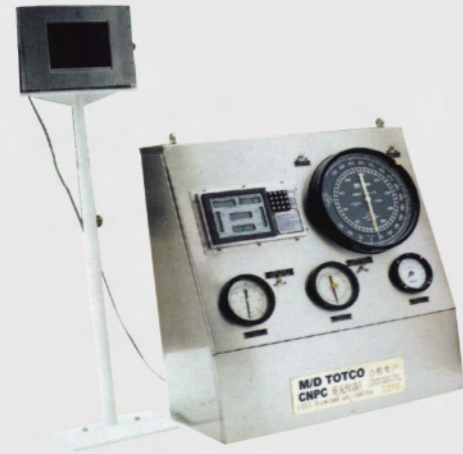

M/C Series Drillwatch (RIG1301)

M/C series Drillwatch is designed under M/D TOTCO Technology with key components from M/D OEM plants.

The parameters include:

- Hook Load
- Rotary Torque
- Tong Torque
- Pump Pressure-
- Rotating Speed of Rotary table
- Stroke of pump
- Return mud flow
- Well Depth



XC Series (RIG1303)

XC system is designed for workover rig and truck-mounted drilling rig to record the following parameters:

- Hook Load
- Rotary Torque
- Tong Torque
- Standpipe Pressure
- Rotary Speed
- Stroke of mud pump

RIG ROLLER CHAIN (RIG15) API 7F

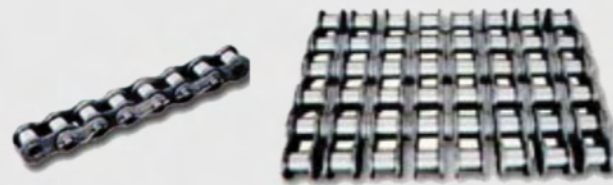

API 7F Spec.

Chain Code	Pitch		Roller Dia	Roller Link inside width (Min.)	Pin Dia (Max)	Pin Length	Height of inn plate	Depth of Plate	Min. Breaking Load
	P	p							
	In	mm	mm	mm	mm	mm	mm	mm	N
80-1	1"	25.40	15.87	15.75	7.94	37.55	24.13	3.18	55600
100-1	1 1/4"	31.75	19.05	18.90	9.54	44.26	30.18	3.96	86840
120-1	1 1/2"	38.10	22.22	25.23	11.11	55.44	36.20	4.75	125100
140-1	1 3/4"	44.45	25.40	25.23	12.71	60.55	42.24	5.56	170270
160-1	2"	50.80	28.57	31.55	14.29	70.00	48.26	6.35	222400
180-1	2 1/4"	57.15	35.71	35.49	17.46	77.7	54.28	7.14	281570
200-1	2 1/2"	63.50	39.67	37.85	19.85	84.50	60.33	7.92	347410
240-1	3"	76.20	47.62	47.35	23.81	102.2	72.39	9.53	500400

ROTARY HOSE (API 7K) (RIG18)

The Rotary Hoses are designed, machined and tested as per API 7K Spec and standards with details data sheet as below.



Working Pressure: 1,600 PSI, 2,000 PSI, 4,000 PSI
 Temperature: -40°C~+100°C
 API 7K
 Used for Drilling, cementing, workover operation



Working Pressure: 5,000 PSI
 Temperature : -40°~+100°
 API 7K
 Used for drilling, cementing, workover, choke and kill line.

ID (inch)	Working pressure (PSI)									End Conn.
	1,600			2,000			4,000			
	Testing Pressure (PSI)									
	3,200			4,000			8,000			
	OD (in)	Weight (lb/ft)	Min. Bending Radius (in)	OD (in)	Weight (lb/ft)	Min. Bending Radius (in)	OD (in)	Weight (lb/ft)	Min. Bending Radius (in)	
1 1/2"	1.988	1.28	22.05	2.00	1.338	22.04	2.283	2.487	21.65	2 3/8TBG
2"	2.670	2.02	35.43	2.69	2.184	35.43	2.909	3.93	35.43	2 3/8TBG
2 1/2"	3.197	2.768	47.24	3.224	2.816	47.24	3.425	4.71	43.31	2 7/8TBG
3"	--	--	--	3.93	5.390	47.24	4.26	9.55	43.31	API T M95
3 1/2"	--	--	--	--	--	--	4.799	11.44	47.24	API TM120
4"	--	--	--	5.03	7.53	55.12	5.437	14.32	51.18	API T
5"	--	--	--	6.0	10.01	59.06	6.701	17.482	55.12	API T
6"	--	--	--	7.24	20.43	62.99	7.681	29.59	62.99	API T

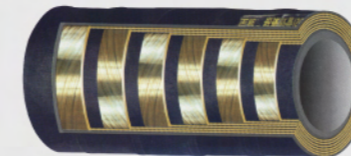

Working Pressure: 7,500 PSI, 10,000 PSI
 Temperature : -40°~+100°
 API 7K, API 16C
 Used for cementing, choke and kill line

ID (inch)	Working pressure (PSI)									End Conn.
	5,000			7,500			10,000			
	Testing Pressure (PSI)									
	10,000			15,000			20,000			
	OD (in)	Weight (lb/ft)	Min. Bending Radius (in)	OD (in)	Weight (lb/ft)	Min. Bending Radius (in)	OD (in)	Weight (lb/ft)	Min. Bending Radius (in)	
1 1/2"	--	--	--	--	--	--	--	--	--	--
2"	3.063	5.444	35.43	3.130	6.788	35.43	3.26	7.595	35.43	2 3/8TBG
2 1/2"	3.693	8.267	43.31	3.980	11.097	43.31	4.07	16.028	43.31	2 7/8 TBG
3"	4.311	9.753	43.31	4.720	16.22	43.31	4.73	16.219	43.31	API T
3 1/2"	5.228	18.376	47.24	--	--	--	--	--	--	--
4"	5.78	20.561	51.18	6.154	31.348	62.992	6.543	35.529	70.87	API T

MUD PUMP

P series Pump

P series Pump is machined, assembly and tested under National Oilwell Designs with parts interchangeable.

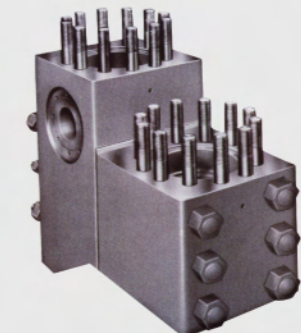
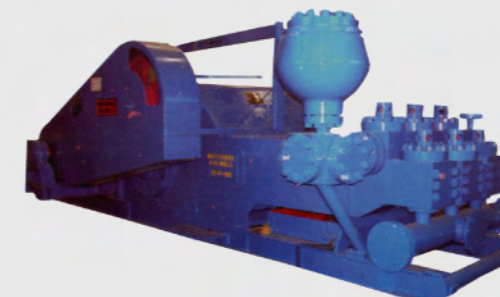

P SERIES PUMP

Order Code	Model	Max. Line Size x Stroke (in)	Strokes rating (SPM)	Power Rating (HP)	Suction Inlet (in)	Discharge outlet (inch)	Valve Pot, API #
MP0109	8P80	6 1/4 X 8 1/2	160	800	8" F	4" F, 5M	6
MP0110	9P100	6 3/4 X 9 1/4	150	1000	8" F	5" F, 5M	6
MP0111	10P130	6 3/4 X 10	140	1300	8" F	5" F, 5M	6
MP0112	12P160	7 1/4 X 12	120	1600	10" F	6" F, 5M	7
MP0113	14P220	9 X 14	105	2200	10" F	6" F, 5M	8

F SERIES MUD PUMP (MP01)

F Series Triplex Single Acting Mud pumps are machined under C. Emsco designs with all fluid end parts interchangeable to those for C. Emsco OEM pump.

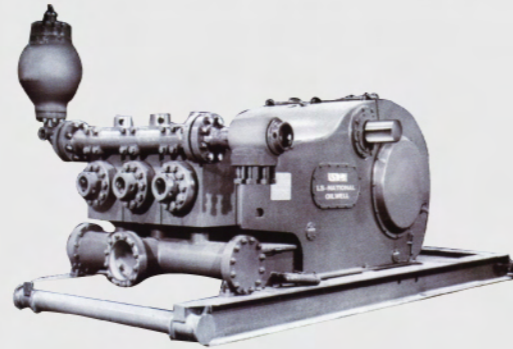

Order Code	Model	Max. Line Size x Stroke (in)	Strokes rating (SPM)	Power Rating (HP)	Suction Inlet (in)	Discharge outlet (inch)	Valve Pot, API #
MP0101	F-500	6 3/4 X 7 1/2	165	500	8" F	4" F, 5M	5
MP0102	F-800	6 3/4 X 9	150	800	10" F	5" F, 5M	6
MP0103	F-1000	6 3/4 X 10	140	1000	12" F	5" F, 5M	6
MP0104	FB-1300	7 X 12	120	1300	12" F	5" F, 5M	7
MP0105	FB-1600	7 X 12	120	1600	12" F	5" F, 5M	7
MP0106	F-1600HL	7 1/2 X 12	120	1600	12" F	5" F, 5M	7
MP0107	F-2200	9 X 14	105	2200	12" F	5" F, 5M	8
MP0108	F-2200HL	9 X 14	105	2200	12" F	5" F, 5M	8



3NB SERIES PUMP

3NB series Pump is machined, assembly and tested by Lanzhou National Oilwell J-V plant in China

Order Code	Model	Max. Line Size x Stroke (in)	Strokes rating (SPM)	Power Rating (HP)	Suction Inlet (in)	Discharge outlet (inch)	Valve Pot, API #
MP0114	3NB500C	6 1/4 X 10	95	500	10" F	4" F, 5M	6
MP0115	3NB100C	6 3/4 X 12	110	1000	12" F	4" F, 5M	6
MP0116	3NB1300C	7 1/8 X 12	120	1300	12" F	4" F, 5M	6
MP0117	3NB1600	7 1/2 X 12	120	1600	12" F	4" F, 5M	7

PZ SERIES PUMP

PZ series Pump is machined assembly and tested under Gardner Denver designs with all fluid end parts interchangeable.

Order Code	Model	Max. liner size & Stroke(in)	Displacement (GPM)	Max. RPM	Power Rating (HP)	Gear Ratio	Weight(lbs)
MP0118	PAH	5x8	357	175	275	4.7:1	9,200
MP0119	PZ-9	7x9	585	130	1000	4.48:1	24,368
MP0120	PZ-11	7x11	632	115	16000	4.38:1	37,000



PLUNGER PUMP (MP02) is light duty pump, which is designed for Workover Rig and small size Drilling Rig.

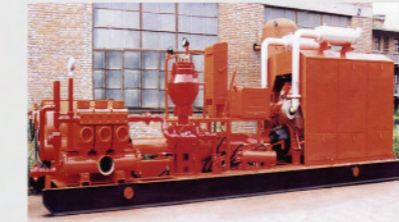

Model	NBQ20-380	NBQ25-380	NBQ35-600	NBQ35-151I
S/N	MP0201	MP0202	MP0203	MP0204
Horse Power HP	500	500	800	300
Max. WP PSI	2900	3625	5075	5075
Max. Flow rate GPM	370	370	528	396

Mud Pump Fluid end parts and Expendables

Full line fluid end parts and expendables are available for the pump of C.Emsco, National, Oilwell, Gardner, and IDECO

- Hy-Chrome Liner
- Chrome-Plated Liners
- Hardened Steel Liners
- Ceramic Liner
- Valve & Valve Rings
- Gaskets
- Snap Rings & Valve Rings
- Pistons & Piston Rubbers
- Plates
- Piston Rod And Extension Rods
- Fluid End Modules
- Crossheads And Crosshead Guides
- Hydraulic Seat Pullers
- Cylinder Heads & Vales Covers
- Threads Rings
- Liner Clamp
- Rod Clamp
- Valve Pot Cover
- Liner Cage
- Wear Plate
- Valve Guide



SHALE SHAKER (S/N SC01)

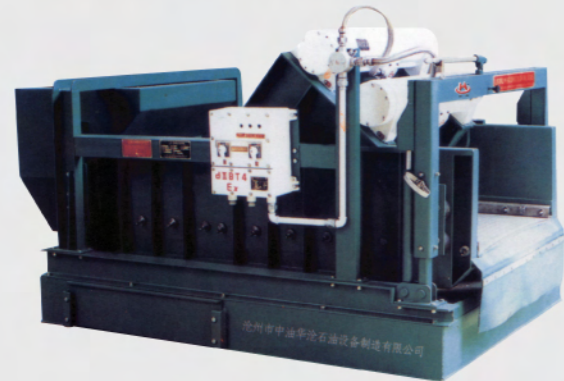

Derrick designs

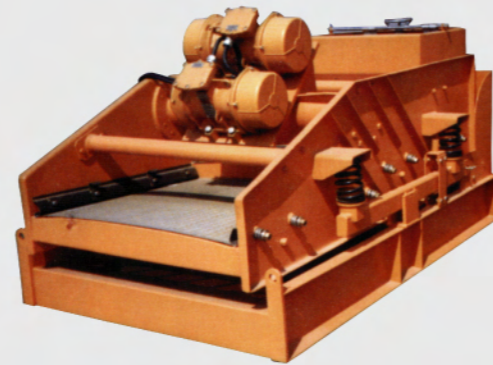

Brandt designs

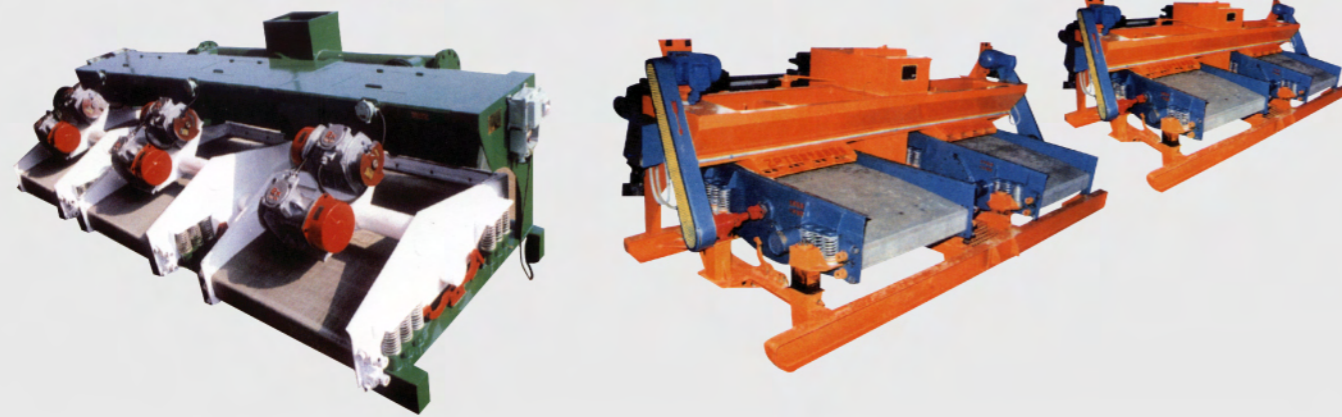

Order Code	Model	Type	Handling Capacity (GPM)	Screen (mesh)	Electrical motor (HP)	Vibrating Amplitude(mm)	Exciting Force (KN)
SC0101	SSL-660	Linear	660	40-220	2 x 2	>6	25 x 2
SC0102	SSL-770	Linear	770	40-220	2 x 2	>5	
SC0103	SSL-800	Linear	800	60-180	2 x 2.5	2-4	
SC0104	SSL-530	Linear	530	40-120	2 X 1.5	5	20
SC0105	SSL-1060	Linear	1060	40-120	4 x 1.5	5	20
SC0106	SSL-1590	Linear	1590	40-120	6 x 1.5	5	20
SC0107	SSE-600	Elliptical	600	40-120	1 x 4	8	25
SC0108	SSE-1200	Elliptical	1200	40-120	2 x 4	8	25
SC0109	SSE-1800	Elliptical	1800	40-120	3 x 4	8	25

DESANDER (S/N SC02)

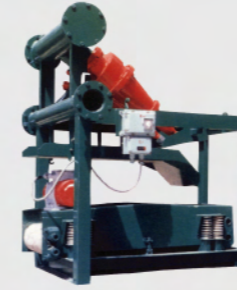

Desander

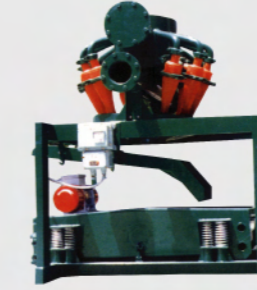

Desilter

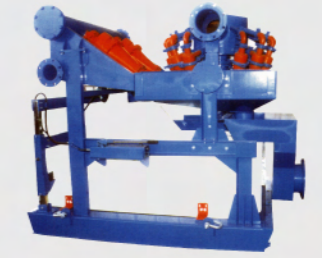

Combination of Desander-Desilter

Model	Desander (SC02)						Desilter (SC03)		
	DS10x1	DS10x2	DS10x 3	DS12x1	DS12x 2	DS12x 3	DS4 3/4 x 8	DS4 3/4 x 10	DS4 3/4 x 16
Handling capacity (GPM)	366	732	1098	439	878	1317	549	677	1098
Motor (HP)	0.7	0.7	0.75	0.7	0.75	0.75	0.7	0.75	0.75
Screen (mesh)	120 / 40						140-180 /40		

Model	Horizontal type Desander Pump				Vertical type Desander Pump			
	DSP-H40	DSP-H50	DSP-H75	DSP-H100	DSP-V25	DSP-V40	DSP-V50	DSP-V75
Handling capacity (GPM)	460	549	732	1024	439	586	659	732
Motor (HP)	40	50	75	100	25	40	50	75



Vertical type Desander Pump



Mixing Hopper (SC07)

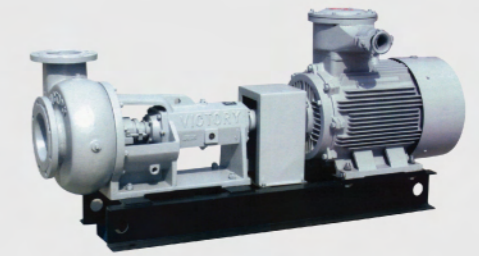

Horizontal Desander Pump (SC05)



Shearing Pump (SC06)

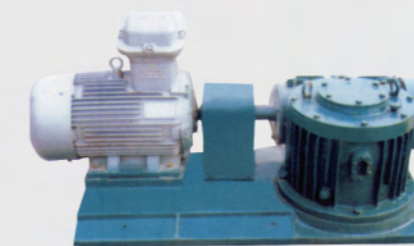

Horizontal type Agitator (SC08)

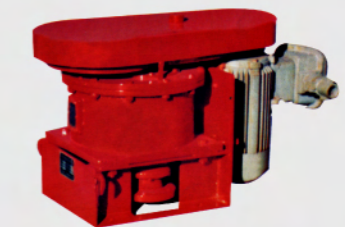

Vertical type Agitator (SC08)

AGITATOR (SC08)

Order Code	SC0801	SC0802	SC0803	SC0804	SC0805	SC0806	SC0807	SC0808
Model	SC-AV01	SC-AV02	SC-AV03	SC-AV04	SC-AV05	SC-AH06	SC-AH07	SC-AH08
HP	7.5	10	15	20	50	10	15	20
Impeller rotating speed (RPM)	60	60	60	60	60	85	85	85
Impeller Dia. (mm)	700 /550	800/650	900/700	1000/800	1500/1200	800/650	900/700	1000/800
Ratio	1:24	1:24	1:24	1:24	1:24			

CENTRIFUGE (SC04)

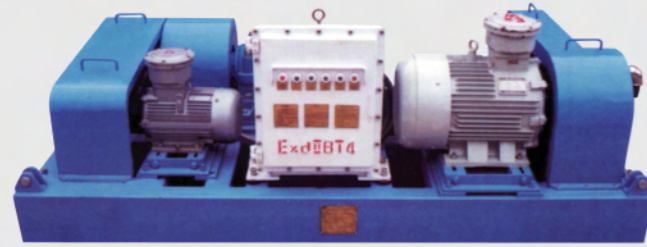

Model	C220-18 X 48	C150-18 X 38	C150-18 X 28
Handling Capacity (GPM)	220	150	150
Bowl size (inch)	18 x 48	18 x 38	18 x 28
Bowl RPM	2000	2000	2000
Separating Factor	1472	1472	1472
Solid size (Um)	3-5	5-7	7-9
Motor (HP)	62	50	40
Feeding Pump (HP)	10	10	10

MUD TANK (SC09)



Standard designs

- 7500 x 2400 x 2000 mm
- 8000 x 2400 x 2000 mm
- 9000 x 2800 x 2200 mm
- 10000 x 2800 x 2500 mm
- 12000 x 2800 x 2500 mm

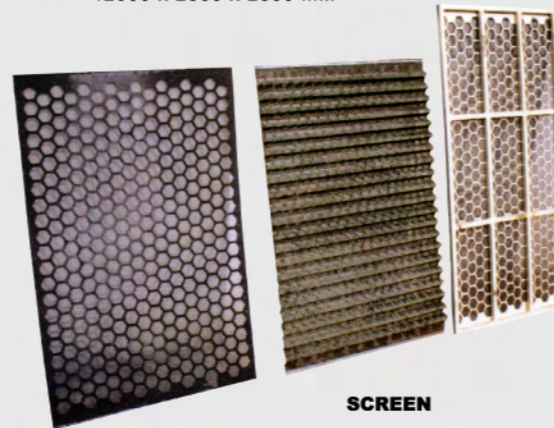

SCREEN

Screen area (MM2)	Screen Mesh									Brands
	12	20	40	60	80	100	120	150	200	
2050 x 1120	✓	✓	✓	✓	✓	✓	✓	✓	✓	-
1060 X 705	-	-	✓	✓	✓	✓	✓	✓	✓	Derrick
1100 X 630	-	-	✓	✓	✓	✓	✓	✓	✓	Brandt
1180 X 758	-	-	✓	✓	✓	✓	✓	✓	✓	Brandt
2050 X 600	✓	✓	✓	✓	✓	✓	✓	✓	✓	-
1060 X 630	-	-	-	✓	✓	✓	✓	✓	✓	-

SLIPS (HT01)

ROTARY SLIPS (HT0101)

SDS, SDML and SDXL Rotary Slips are for use in API Standard insert Bowls.

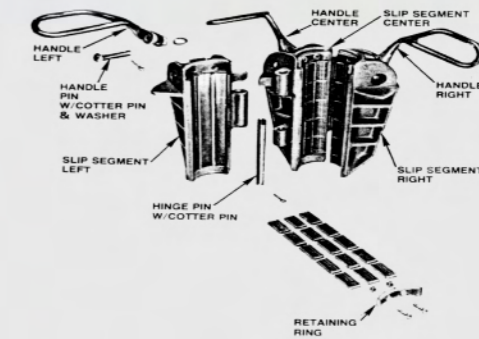

DRILL COLLAR SLIPS (HT0102)

Varco DCS designs

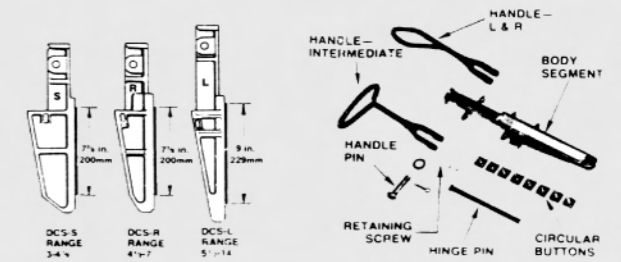

DP Size	2 3/8"	2 7/8"	3 1/2"	4"	4 1/2"	5"	5 1/2"	6 5/8"	7"			
SDS	3901	3903	3905	3909	3911							
SDML	15524	15523	15522	15564	15565	15569	15573					
SDXL			15515	15514	15517	15520	15519	86720	86719			
DC Size	3	4	4 1/2	5 1/2	6	7	8	9	10	11	12	14
DSC-S	2572	2573										
DCS-R			2552	2552	2550	2550						
DCS-L					2503	2507	2507	2507	2530	2534	2536	2536

CASING SLIPS (HT0103)

Varco CMS-XL slips are designed to handle casing from 6 5/8" to 30 inches OD. All slips have an API taper of 4"/ft on the diameters.

All CP-S slips (Conductor Pipe Slip) are furnished with 4 handles.



CSG Size	6 5/8"	7	7 5/8	8 5/8	9 5/8	10 3/4	11 3/4	13 3/8	16	18 5/8	20	24	26	30
CMS-XL	5315	5301	5398	5305	5307	5309	5311	5313	5325	5333	5329	5331	5346	5342
CP-S												5338	5344	5340

SLIP TYPE ELEVATORS "Y" SERIES (HT0201)

"Y" series elevators are conventional slip type elevators for handling tubing and small casing. There are 7 types ranging from 20 to 200 ton capacity and covering pipe sizes from 1.050" to 7 5/8" OD. "YC" type elevator is capable of handling dual tubing strings. All type "Y" series elevators operate with the latch lock combination for safety. The "MYC" and "YC" provide a 7" and the "HYC" a 10 1/2" of insert contact to grip your casing or tubing.

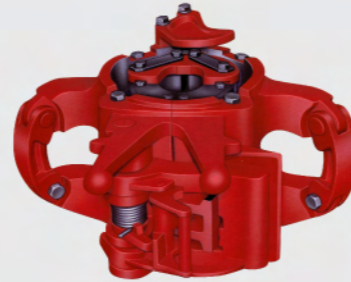
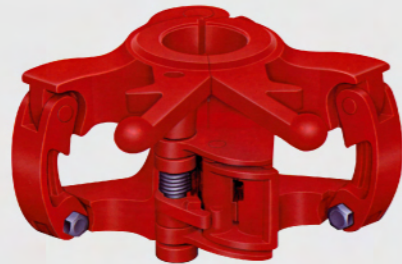

COLLAR TYPE ELEVATOR "A" SERIES (HT0202)

Center-latch elevators are for handling collar-type drill pipe, casing and tubing. All "A" type elevators are constructed in two halves of practically the same weight, providing proper balance and easier opening and closing. In open position All "A" type elevators feature latch and safety latch lock combinations.

Size in (mm)	Type	Cap Tons
Slip Type Elevator Y Series		
1.05-2 1/16	27-52	LYT 20
1.315-2 7/8	33-73	MYT 40
1.315- 3 1/2	33-89	YT 75
2 3/8- 3 1/2	60-89	HYT 150
3 1/2-7	89-178	YC 75
3 1/2-7	89-178	MYC 125
2 7/8-7 5/8	89-194	HYC 200
2 7/8-7 5/8	89-194	HYC AO 200
Collar Type elevator A series		
1.050-2 1/2	27-73	TA 35
1.66-2 7/8	42-73	TA 65
3 1/2-4 1/2	89-114	TA 65

Size in (mm)	Type	Cap Tons
Collar Type elevator A series		
2 3/8-2 7/8	60-73	TA 100
3 1/2-5	89-127	TA 100
4 3/4-8 5/8	121-219	TA 100
4 1/2-8 5/8	114-219	TA 150
4 3/4-8 5/8	121-219	TA AO 150
8 1/2-11 1/4	216-286	TA 150
8 1/2-11 1/4	216-286	TA AO 150
2 3/8-4 1/2	60-114	RGA 200
3 1/2-7	102-178	GA 350
3 1/2-7	102-178	GA AO 350
7-7 5/8	178-194	GGA 350
7 -7 5/8	178-194	GGA AO 350

18°Type Elevators

G SERIES (HT0203) G series elevators are similar in design and construction to the A Series, except they are bored to fit the contour of 18° type Drill pipe. They are constructed in two halves of practically the same weight for better balance, making them easier to handle, easier to latch on and take off the pipe. In open position, a G-series elevator hangs ready for closing at any point below the upset of the pipe. Safety features include guarded operating handles to help prevent accidents to operators and an extra handle at the rear of the elevator for easier, safer operation.

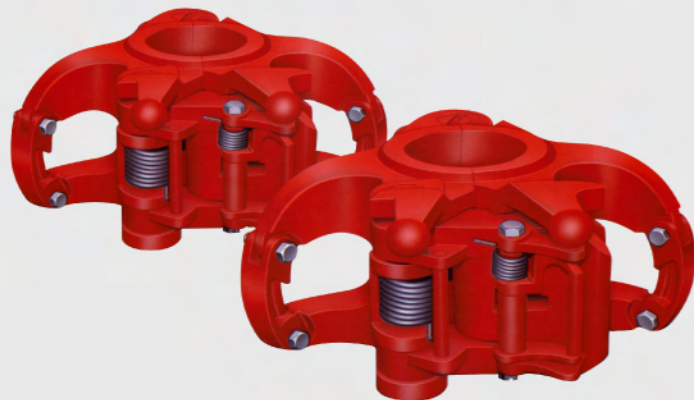

Size in (mm)	Type	Cap Tons
18°Type Elevators G series		
2 3/8-5	60-127	MG 100
2 3/8-3 1/2	60-89	RGG 150
3 1/2-5 1/2	89-140	MGG 250
3 1/2-5 1/2	89-140	MGG AO 250
4-5 1/2	102-140	GG 350
4-5 1/2	102-140	GG AO 350
4-6 5/8	102-168	HGG 500
4-6 5/8	102-168	HGG AO 500
Bottleneck center latch elevator		
4-5 1/2	102-140	BNC 350

Air Operated Elevators

TA-150 is a center-latch elevator for handling zip groove drill collars from 4 3/4" to 11 1/2" with a capacity of 150 tons. The GG is a center-latch elevator for handling 18-degree external upset drill pipe from 4" to 5 1/2" with a rated capacity of 350 tons. The HGG handles the same pipes from 4" to 6 5/8" with a 500 ton rated capacity. The MGG is also a center-latch elevator for handling 18-degree external upset drill pipe sizes 3 1/2" to 5 1/2" with a rated capacity of 250 tons. The HYC is a slip type elevator to handle tubular from 2 7/8" thru 7 5/8" rated capacity 250 ton.

18°Type Elevator BNC Model

The BNC has a center latch elevator for handling 18° external upset drill pipe and tubing the inside surface of this elevator is induction hardened to provide maximum strength and long services.

SIDE DOOR TYPE ELEVATORS X SERIES (HT0204)

The X-Series elevators handle all sizes of collar-type tubing, drill pipe and casing. The SLX has a shielded safety latch mounted on the elevator door. The shield protects the latch from accidental opening. Both latches operate from a single handle, and then automatically re-latch when the elevator door is closed. The type SX side-door elevator, designed for handling large, collar-type casing, is a sturdier, safety-latch-equipped version of X-series elevators.



AUXILIARY ELEVATOR SJL AND SPL (HT0205)

Single-joint, center-latch elevator designed to replace unsafe rope slings for hoisting collar-type pipe into position. The SJL type enables the crew to handle pipe properly, helps to avoid damage to pipe threads and reduces the chance of accident or injury, the SPL is the same as the SJL type except that the SPL is designed for use on tapered pipe.

Size in (mm)	Type	Cap tons
Collar type Side Door elevator X series		
1.660-2 7/8	42-73	SLX 65
2 3/8-2 7/8	60-73	SLX 100
3 1/2-4	89-102	SLX 100
4 1/2-5 1/2	110-140	SLX 100
5 1/2-8 5/8	140-219	SLX 150
9 5/8-10 3/4	245-273	SLX 150
11 3/4-13 3/8	298-340	SLX 150
16	406	SLX 150
18 5/8-20	473-508	SLX 150
26-30	660-762	SLX DD 150
6 5/8-7 5/8	168-194	SSD 250
8 5/8-10 3/4	219-273	SSD 250
11 3/4-14	298-356	SDD 250
18 5/8-20	473-508	SX 250
22-24 1/2	559-622	SLX 250
9 5/8-13 3/8	244-340	SX 350
9 5/8-13 3/8	244-340	SX 500
16	406	SX 500

Size in (mm)	Type	Cap tons
Auxiliary elevators S series		
2 3/8-3 1/2	60-89	SJL 5
4-5 1/2	102-140	SJL 5
6-7 5/8	152-194	SJL 5
8 5/8-10 3/4	219-273	SJL 5
11 3/4- 13 3/8	298-340	SJL 5
14	356	SJC 5
16-20	406-508	SJL 5
21-24 1/2	533-622	SJL 5
2 7/8- 5 1/2	72-140	SPL50 5
5 1/2-7 5/8	140-194	SPL50 5
8 5/8-9 5/8	219-244	SPL50 5
9 7/8	251	SPL50 5
10 3/4	273	SPL50 5
2 3/8-4 1/2	60-114	SPL120 5
2 7/8-5	73-127	SPL180 5
5 1/2-6 3/8	140-168	SPL180 5



Baash Ross Type T Safety Clamp

Type T Safety Clamp is designed for small diameter pipe 1 1/8 thru 4 1/2 inch OD. Each link changes the effective working range approximately 1 inch in diameter. For size larger than 4 1/2 inch OD, the Type C Safety Clamp should be used.

Total No. links REQ'D per range	Range OD Size		P/N
	From	To	
4	1 1/8	2	7624-5044
5	2 1/8	3 1/4	7624-5045
6	3 1/4	4 1/2	7624-5046

Item No.	Item	No. REQ'D	P/N
1	Link Assy, complete	As ordered	7624-B-7
2	Link, Intermediate	1	7624-A-18
3	Slip with Cotter	1	7624-A-21
3A	Cotter, for slips (1/4")	1	900620-52
4	Slip Spring	1	7624-B-21
5*	Link pin with cotter	1	7624-C-5
5A*	Cotter, for link (3/16")	1	900620-36
6	End link (Screw)	1	7624-A-20
7	End link (Pivot Block)	1	7624-A-19
8*	End link pin with Chain	1	7624-F-5
9*	Screw	1	7624-A-5
10*	Nut	1	7624-B-5
11*	Nut wrench	1	7624-A-25
12*	Pivot Block	1	7624-A-5000
13*	Pivot Block Pin	2	7624-D-5
14*	Pivot Block pin wrench	1	900533-12
15*	Handle	1	7624-A-6
16*	Handle link pin w/ Cotter	2	7624-G-5
25*	Equipment Box	1	7624-A-9

* These parts are interchangeable with the C type Clamps.



Type C Safety Clamp (Baash Ross)

Total No links REQ'D Per Range	Range OD sizes		P/N
	From	To	
Type CR (Single Screw)			
7*	3 3/4	4 5/8	7624-5007
8	4 1/2	5 5/8	7624-5008
9	5 1/2	6 5/8	7624-5009
10	6 1/2	7 5/8	7624-5010
11	7 1/2	8 5/8	7624-5011
12	8 1/2	9 5/8	7624-5012
13	9 1/2	10 5/8	7624-5013
Type CL (Single Screw)			
14	10 1/2	11 5/8	7624-5014
15	11 1/2	12 5/8	7624-5015
16	12 1/2	13 5/8	7624-5016
17	13 1/2	14 5/8	7624-5017
18	14 1/2	15 5/8	7624-5018
Type CXL (Double Screw)			
18	15 1/2	17	7624-5029
19	16 1/2	18	7624-5030
20	17 1/2	19	7624-5031
21	18 1/2	20	7624-5032
22	19 1/2	21	7624-5033

*7-Slip clamp only, carries one handle; all other type CR and CL clamps with handles carry two handles, except CXL, which carries four handles per complete clamp.

Item No.	Item	No REQ'D	P/N
1	Link Assy complete	As ordered	7624-A-7
2	Link Intermediate	1	7624-A-1
3	Slip with Cotter	1	7624-A-4
3A	Cotter for slip (5/16")	1	90062-65
4	Slip Spring	1	7624-E-5
5	Link pin with Cotter	1	7624-C-5
5A	Cotter for link pin (3/16")	1	900620-36
6	End Link (Screw)	*	7624-A-3
7	End link (Pivot Block)	*	7624-A-24
8	End link Pin with Chain	*	7624-F-5
9	Screw	*	7624-A-5
10	Nut	*	7624-B-5
11	Nut wrench	*	7624-A-25
12	Pivot block	*	7624-A-5000
13	Pivot Block Pin	**	7624-D-5
14	Pivot Block pin Wrench	1	900533-12
15	Handle	As ordered	7624-A-6
16	Handle link pin with cotter	As ordered	7624-G-5
17	Hold Down ear, complete	2	7624-26
18	Hold Down ear, only	2	7624-A-13
19	Pins with nuts and cotter	4	7624-B-13
20	Eye Bolt	2	7624-30A
21	Cap Screw	2	7624-30B
22	Lifting clevis, complete	2	7624-29
23	Lifting clevis, only	2	7624-A-29
24	Pins with nuts and cotters	4	7624-A-30
25	Equipment Box	1	7624-A-9

* One required on Type CR and CL, two required on type CXL
 ** Two required on type CR and CL, four required on type CXL

MPCH (HT0401)

The 37 1/2" MPCH Master Bushing is a pin drive hinged master bushing specially designed for floating and semi-submersible drilling operations. With Insert bowl No.3 and optional inserts bowl No. 1 and No. 2, the MPCH will handle tubular from 2 3/8" to 13 3/8"OD.



MSPC (HT0402)

The 20 1/2" thru 27 1/2" MSPC is a solid body pin drive Master Bushing designed for all drilling operations. The pin drive allows the Kelly bushing to ride on top of the rotary table and permits extended bowls to be used for better slip back up. With the extended API insert bowl No.3, the MSPC will handle tubular from 2 3/8" to 13 3/8".

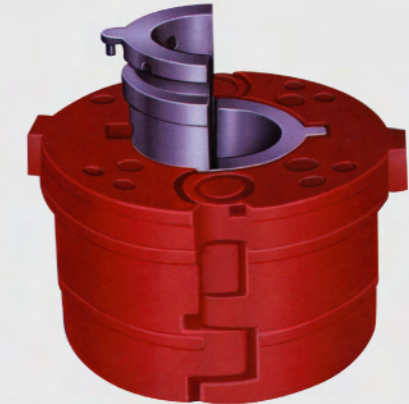

MDSP (HT0403)

17 1/2" and 20 1/2" Medium Duty Drive Split Master Bushing is designed for shallow to medium depth service.

MSP (HT0404)

MSP 27 1/2" Split pin Drive Bushings with the standard No.3 extended API Taper is for larger rotary opening. And this allows the use of extra-long SDXL slips required for heavier loads.

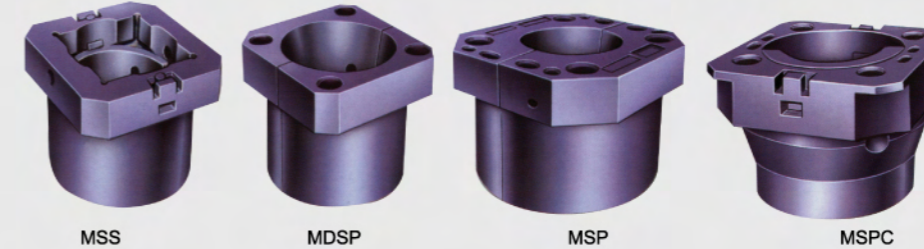

MASTER BUSHING SELECTION CHARTS

Make	Size					MSP/MDSP
		Complete	Body	Complete	Body	Complete
API Standard	27 1/2"	-	-	1804-1	1808-1	5429-1
Emsco	T-2750	-	-	1804-1	1808-1	5429-1
	G-27 1/2	-	-	1804-5	1808-5	5429-5
	H-27 1/2	-	-	1804-2	1808-2	5429-2
	K-27 1/2, KS, P1	-	-	1804-3	1808-3	5429-3
	T-3750 (S/N 1-48)	6600-2A	6601-2A	-	-	-
Gardner Denver	T-3750 /T-4950 (49/up)	6600-2	6601-2	-	-	-
	RT-27 1/2	-	-	1804-1	1808-1	5429-1
Ideco	RT-37 1/2	6600-7	6601-7	-	-	-
	27 1/2	-	-	1804-7	1808-7	5429-7
	37 1/2	6600-4	6601-4	-	-	-
National	MS-27 1/2, A & B-27 1/2	-	-	1804-5	1808-5	5429-5
	C-365	6600-5	6601-5	-	-	-
Oilwell	C-375	6600-1	6601-1	-	-	-
	A-27 1/2	-	-	1804-1	1808-1	5429-1
Wirth	A-37 1/2	6600-3	6601-3	-	-	-
	27 1/2	-	-	1804-1	1808-1	5429-1
	37 1/2	6600-3	6601-3	-	-	-



**ROLLER KELLY BUSHING (API 7K)
(HT0405)**

Model	Type	Drive style	Master Bushing	Square Kelly size	Hex Kelly size
27 HDS	Heavy	Square	23-49 1/2 inch	3-6	3-6
27 HDP		Pin	23-49 1/2 inch	3-6	3-6
20 HDP		Pin	20 1/2-22 1/2 inch	3-6	3-6
RTM4	Medium	Square		2 1/2-5 1/4	3-4 1/4
20 MDP		Pin	20 1/2 MSPC and MDSP	2 1/2-4 1/4	3-4 1/4
17 MDP		Pin	17 1/2 MSPC and MDSP	2 1/2-4 1/4	3-4 1/4
MDS		Square	17 1/2-27 1/2 inch	2 1/2-4 1/4	3-4 1/4
4 KRVS	Light	Square		2 1/2-5 1/4	3-4 1/4
RTS4		Square		2 1/2-4 1/4	3-4 1/4
4 KRBM		Square		2 1/2-4 1/4	3-4 1/4

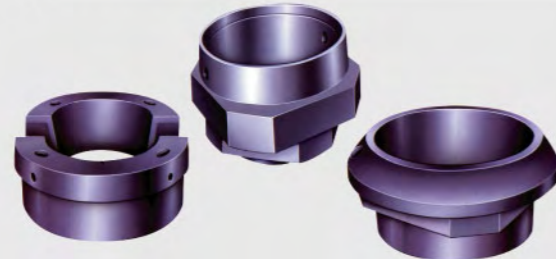

CASING BUSHING (HT0406)

Rotary Table		Casing Size	Casing Bushing and Insert P/N
Size	Manufacturer		
17 1/2-20 1/2	All	11 3/4, 13 3/8, 9 5/8 and 10 3/4	CU (3102) W/ insert Bowl No.2 (1902)
26, 27 1/2	All	18 5/8, 20 2 3/8- 8 5/8 11 3/4, 13 3/8 16	CUL (31033) W/ insert Bowl No.3 (1809) W/insert Bowl No.1 (3105) W/insert Bowl 20 x 16 (3104)
27 1/2	All 27 1/2 API	20 9 5/8, 10 3/4 11 3/4, 13 3/8 16	CB (6695) W/insert Bowl No.2 (16114) W/insert Bowl No.1 (6126) W/insert Bowl 20 x 16 (6127)
37 1/2-49 1/2	National	20 9 5/8, 10 3/4 11 3/4, 13 3/8 16 24 16 18 5/8, 20 26 30	CB (10187) W/insert Bowl No. 2 (6114) W/insert Bowl No. 1 (6126) W/insert Bowl 20 x 16 (6127) CB (11253) W/insert Bowl 24 x 16 (11486) W/insert Bowl 24 x 18 5/8, 20 (16964) CB (16454) CB (11763)
37 1/2-49 1/2	Oilwell	20 9 5/8, 20 3/4 11 3/4, 13 3/8 16 24 16 18 5/8, 20 30	CB (10188)W/insert Bowl No. 2 (6114) W/insert Bowl No.1 (6126) W/insert Bowl 20 x 16 (6127) CB (6170) W/insert Bowl 24 x 16 (11486) W/insert Bowl 24 x 18 5/8.20 (16964) CB (12093)
37 1/2-49 1/2	EMSCO	20 9 5/8, 10 3/4 11 3/4, 13 3/8 16 24 16 18 5/8, 20 30	CB (11553) W/insert Bowl No.2 (6114) W/insert Bowl No.1 (6126) W/insert Bowl 20 x 16 (6127) CB (16542) W/insert Bowl 24 x 16 (11486) W/insert Bowl 24 x 18 5/8.20 (16964) CB (11633)
37 1/2	IDECO	20 9 5/8, 10 3/4 11 3/4, 13 3/8 16 30	CB (10189) W/insert Bowl No. 2 (6114) W/insert Bowl No.1 (6126) W/insert Bowl 20 x 16 (6127) CB (12092)

Varco The Hinged Casing Spider (HCS) (HT0501) has a capacity of 500 tons and handles 9 5/8" to 20 inch casing. The HCS Hinged casing spider, without insert Bowls, will handle 18 5/8" and 20 inch casing. Three insert bowls are available, and alone or in combination, can handle the bushing's range of 9 5/8 to 16 inch diameter casing.

- Insert Bowl 6114 stacked w/6126 can handle 9 5/8 & 10 3/4 Inch OD Casing.
- Insert Bowl 6126 can handle 11 3/4 & 13 3/8 inch OD Casing
- Insert Bowl 6127 can handle 16 inch OD Casing.

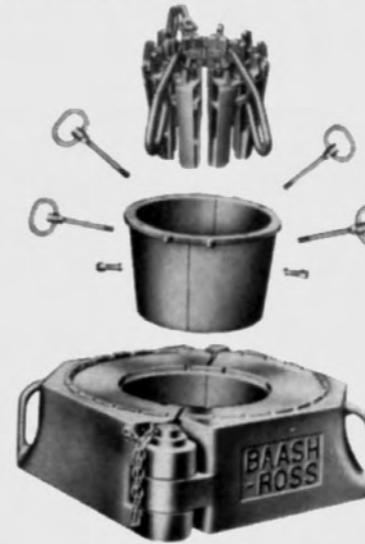

The Baash-Ross 200 ton hinged casing spider will fit most casing handling operations. It can be placed on the rotary table, mounted on a platform which replaces the rotary table, or supported by cribbing, depending upon the auxiliary equipments and procedure to be followed. Spider Bushing for handling casing 9"OD and larger are equipped with a spherical diameter tapered bore. All spiders bushing to handle 8 5/8" OD casing and smaller have a tapered bore dimensionally the same as the API Standard rotary master Bushing and will accommodate any standard rotary slip.

The Cavins "Advance" Spider (HT0503) is available in five models. Model "B", "C", "C-HD", "F", and "G". All are designed for manual, compressed air, or hydraulic operation with the exception of model "G" which is available for compressed air or hydraulically operation only.

All Cavins "Advance" Spiders may be used on a rotary table with an adapter plate that fits into the square drive or pin drive master bushing, centering the spider on the rotary table. Model "B", "C", and "C-HD" spiders may be equipped with a Gate and slips which are relieved to pass parallel strings of tubing.

Model "F" offers manual, pneumatic (air) or hydraulic operation mechanisms. The Model "F" spider can handle tubular goods ranging in size from 2 3/8" OD thru 8 5/8" OD and is favored for automation in light drilling operation or for heavy workover and production rigs. The load capacity for the Model "F" spider is 400,000 lbs.

Model "G" spiders for heavy Drilling Operation, up to 700,000 pounds (350 tons) hook load capacity, The Model "G" spider will handle tubular goods ranging in size 2 3/8" thru 13 3/8" OD and is available for pneumatic (air) or hydraulic operation. Type "FCR" Full Circle slips with replaceable Type "FCI" inserts, are used for the complete range of sizes in the Model "G" spider. The long 16" gripping area plus 360 degree, 100% contact of the type "FCI" inserts, makes it the most positive pipe holding device of its kind.

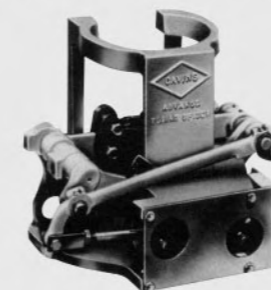

CHD Spider



UC Casing Slips

Most casing strings weight and the relatively thin pipe wall make it important that the supporting slips provide full circumferential grip. The Baash-Ross type UC Slips achieves this with many narrow segments. They are hinged together to wrap around the casing and exert a more uniform pressure. With each segment carrying the same load, they automatically center the casing string within the bushing or spider.

The UC-3 has a 3" Taper, with changes in the number of segments and liners, it will handle strings from 7" OD to 42"OD. Liners are in place by a liner retainer key and cotter pin.



**FIG. 1
Type UC-3
Casing Slips**

Type UC-4 casing slips have a 4" taper



Type C spider

TUBING SPIDER (TS) (HT06)

TS-50 is designed for 50 ton load capacity to handle 1.315 inch thru 3 1/2 inch OD tubing while TS-100 is designed for 100 ton load capacity to handle 2 3/8 inch thru 3 1/2 inch OD Tubing.



CASING ELEVATOR /SPIDER (HT07)

Slip action is controlled by a conveniently positioned pneumatic control valve, or in the case of the 200-ton tools, by simple manual operation. All pneumatically controlled units operated by utilizing the rig air supply. For maximum crew safety, the system may be manually operated if rig air pressure is temporarily lost. Further safety is insured by a positive locking mechanism, which locks slips in the set position.



Varco designs

BJ Designs

BJ Designs

Casing size (inches)	350 ton capacity			500 ton capacity		
	Slip set P/N	Insert Set P/N	Qty Insert	Slip Set P/N	Insert Set P/N	Qty Insert
6 5/8	11861	2632-24B-36	60	13841-3	2632-24B-48	72
7	11860	2623-24B-36	60	13841-2	2623-24B-48	72
7 5/8	11859	2633-60	60	13841-1	2633-72	72
8 5/8	11857	2640-32B-48	80	13840-3	2640-32B-64	96
9 5/8	11856	2633-80	80	13840-1	2633-96	96
9 7/8	71591-1	2649-80	80	13840-2	2649-96	96
10 3/4	11854	2640-40B-60	100	13839-3	2640-40B-80	120
10 7/8	71590-1	2650-40B-60	100	13839-4	2650-40B-80	120
11 3/4	11853	2637-100	100	13839-2	2637-120	120
13 3/8	70732-5	2636-40B-60	100	70734-5	2636-40B-80	120
13 1/2	70732-4	2652-40B-60	100	70734-4	2652-40B-80	120
13 5/8	70732-3	2653-40B-60	100	70734-3	2636-40B-80	120
14	70732-1	2635-100	100	70734-1	2635-120	120
16				15790-4	2635-180	180
18 5/8				15790-3	13868-420	420
20				15790-2	1635-180	180
24				15790-1	1635-180	180

MT SERIES MANUAL TONG (HT08) are offered in torque ranges from the lightweight small 16,000 lb-ft "SLF" to the larger and more rugged 100,000 lb-ft "SDD" and are completely interchangeable with other major manufacturer's tongs (Varco BJ, Woolley, National Oilwell). Each tong features tough, heavy-duty designs with heat-treated hinge pins and long-lasting "stagger tooth" tong dies (Blue Diamond, Pyramid)

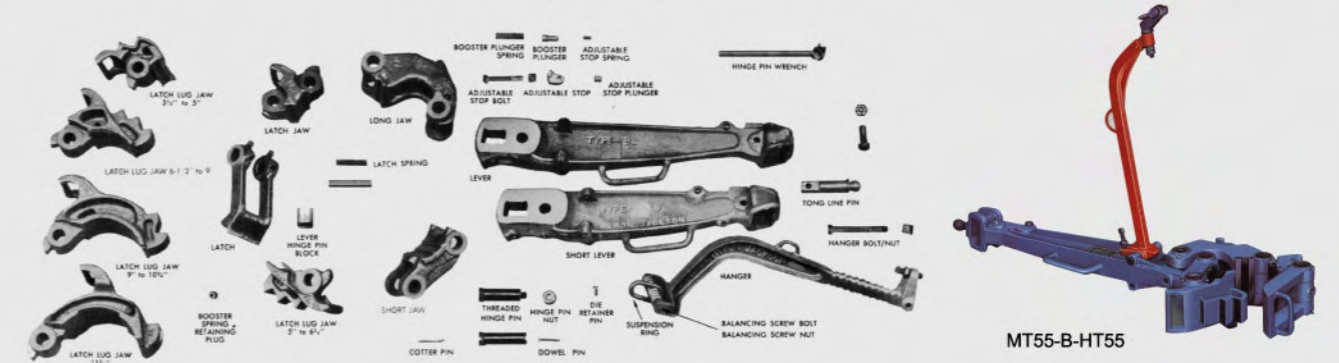

Parts view, BJ Type "B" Tong

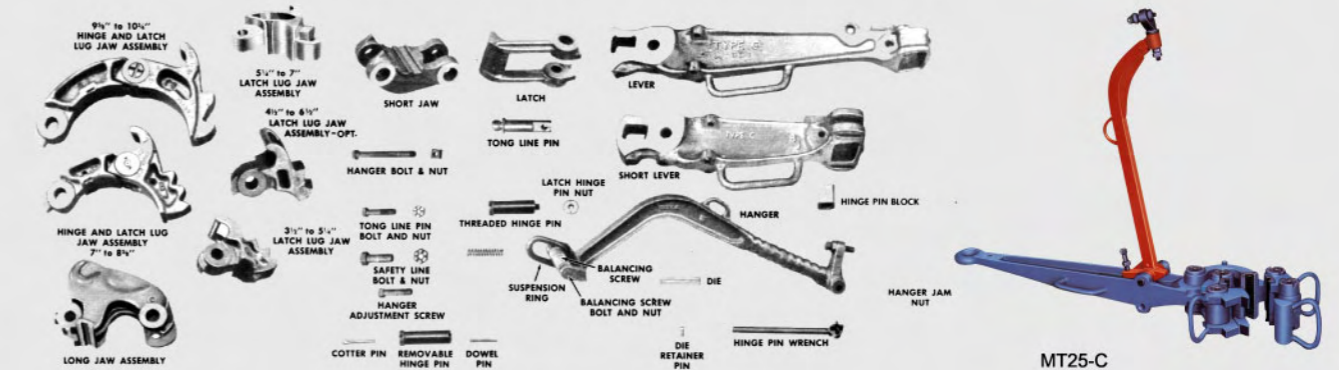

Parts view, BJ Type C tong for drill pipe and casing through 10 3/4" O.D.

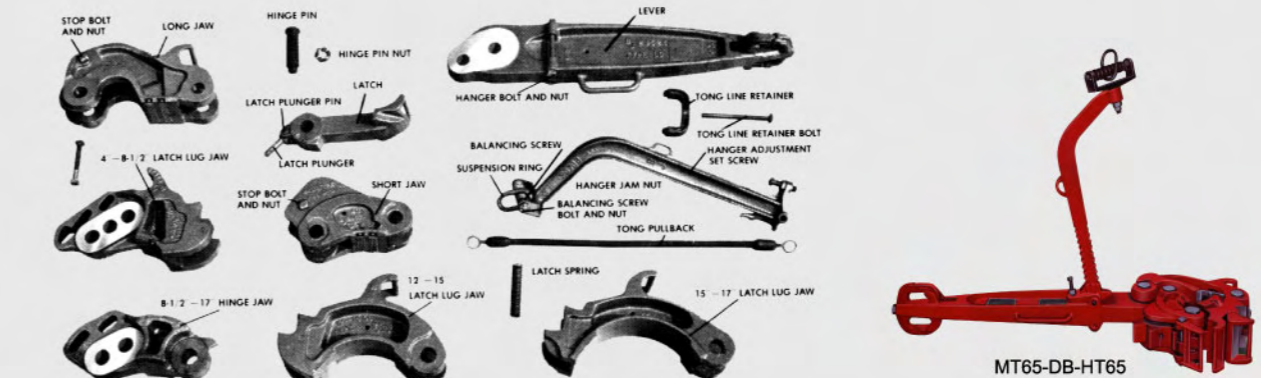

Parts view, BJ Type "SDD" and "DB" Tongs

Model	Jaw Size (inch)	Torque rating (lb-ft)
MT75-SDD	12-15	75,000
MT60-SDD	16-17	60,000
MT65-DB-HT65	3 1/2-11 1/4	65,000
MT40-DB	11 3/4-17	40,000
MT55-B-HT55	3 3/8-9	55,000
MT40-B	9-11 3/4	40,000
MT25-B	13 3/8-30	25,000
MT25-C	2 3/4-10 3/4	25,000
MT16-SLF	2 3/8-8 5/8	16,000



Parts View, BJ Types F and LF Tongs.

Power Drill pipe Tong (PDT Seris power) (HT0901)

Hydraulically powered PDT series power drill pipe tong makes up and breaks out drill pipe tools joints and drill collar from 2 3/8 inch up to 8 inch with max 100,000 lb-ft make-up torques. PDT has a long reach. PDT is designed to move on rails attached to the rig floor. Proper length and location of rails keeps the spinning and torque wrench carriage clear of drill pipe elevator operations. It also provides sufficient travel to cross over the rotary table and make mousehole connections. Two designs for traveling cylinder. One is air driven for quicker movement while hydraulically driven one keeps the movement smooth and safer. Hydraulically adjustable system has a 6-foot vertical travel range, so it can locate at the exact tool joint height. Two designs for power supply. One is for the working temperature less than 45 centigrade while second designs with wind-cooling system on is for the temperature above 45 Degree. Diesel driven power supply is also available as per Customer requirements.



Lifting cylinder



Accessory to Drill pipe tong for pipe from 2 7/8 thru 9 1/2 inch with 600-1972 lb-ft torque range.

Model	PDT8-100	PDT8-92	PDT8-74	PDT8-55	PDT638-37	PDT5-18
Tool joints size inch	3 1/2-8	5-8	5-8	5 1/2-8	3 3/8-6 3/8	2 9/16-5
Max. Torque lb-ft (N.M)	100,000	92,200	73,750	55,000	36,800	18,440
The Speed of tong head (Hi) RPM	35	40	40	40	60	65
The Speed of tong head (Lo) RPM	2.5	2.7	2.7	2.7	4.1	10.5
Hydraulic system pressure rating (PSI)	2320	2900	2400	2320	2320	1740
Hydraulic system flow rate (GPM)	30	30	30	32	32	48
Stroke of shifting cylinder (in)		59	59		39.4	39.4

POWER CASING TONGS (PCT SERIES) (HT0902) are designed for casing from 4 inch thru 13 3/8" with max 25,800 lb-ft make-up torque capacities. The PCT Series Power Casing tongs can share the same one Power supply as that for PDT Series Power Drillpipe tong.

Model	PCP7-12	PCP1338-15	PCP1338-26
Casing size inch (mm)	4-7 (101.6~178)	4-13 3/8 (101.6~340)	5 1/2-13 3/8 (139-340)
Power supply pressure (PSI)	2600	2300	2600
Power supply flow rate (GPM)	30	30	30
Max. Torque (Hi) lb-ft (N.M)	2,200 (3,000)	2700 (3,700)	2,200 (3,000)
Max. Torque (Mid) lb-ft (N.M)	--	--	5,500 (7,500)
Max. Torque (Lo) lb-ft (N.M)	12,000 (16,000)	15,000 (20,000)	26,000 (35,000)
Rotating speed (Hi) RPM	54-79	50-80	60-86
Rotating Speed (mid) RPM	--	--	21-30
Rotating Speed (Lo) RPM	9-13	6-14	2.6-5.3



POWER TUBING TONG (PTT SERIES) (HT0903) is designed to handle tubing from 2 3/8 inch thru 5 1/2 inch with max. 15,000 lb-ft. Motor driven power supply is available.



PTT35-2400



PTT55-15000

Model	PTT35-2400	PTT45-4400	PTT55-8800	PTT55-15000
Tubing size inch	2 3/8-3 1/2	2 7/8-4 1/2	2 7/8-5 1/2	2 7/8-5 1/2
Rated Torque (hi) lb-ft (N.M)	937 (1270)	1210 (1650)	1900 (2600)	1700 (2300)
Rated Torque (Lo) lb-ft (N.M)	2,400 (3,300)	4,400 (6,070)	8,800 (12,000)	15,000 (20,000)
Max. Speed (Hi) RPM	60	62	72	76
Max. Speed (Lo) RPM	23	17	14	8.7
Power supply (PSI)	1450	1595	1740	1885
Max. Flow rate of power supply (GPM)	21	26	32	32

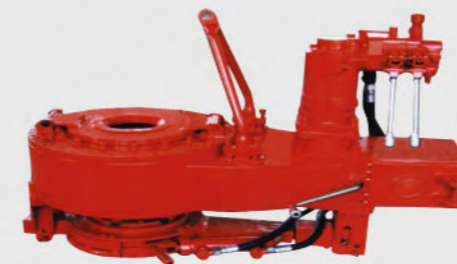

Gear-Driven 2 3/8-3 1/2" Rated Torque: 6000 lb-ft XQB89/8A



Chain-Driven 2 3/8-3 1/2" with Rated Torque 6000 lb-ft XQB89/8

POWER SUCKER ROD TONGS (PSRT SERIES) (HT0904) are designed to handle sucker rod from 5/8 thru 1 1/8 with Max. 1920 lb-ft make-up torque



Model	PSRT118-1300	PSRT118-1900
Sucker Rod sizes inch (mm)	5/8-1 1/8 (16-28)	5/8-1 1/8 (16-28)
Rated Torque (hi) lb-ft (N.M)	500 (700)	740 (1000)
Rated Torque (Lo) lb-ft (N.M)	1300 (1800)	1900 (2600)
Rated Speed (Hi) RPM	104	98
Rated Speed (Lo) RPM	40	32
Power supply Pressure (PSI)	1450	1450
Power supply oil flow rate (GPM)	17	21

POWER STATION

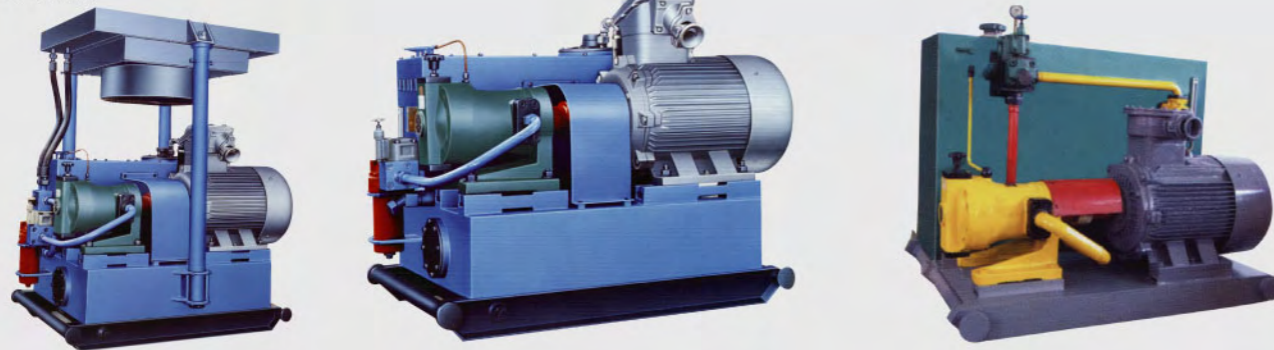

Model	YZB-120	FYZB-120	YD160-I	YD160-II
Max. Pressure (PSI)	2900	2900	2860	2860
Flow Rate (GPM)	31.7	31.7	35.2	35.2
Available oil Volume (Gallon)	155	155	110	110
Motor for air fan (HP)	--	1.5	--	--
Motor for power station (HP)	50	50	50	50
Overall Dimensions (inch)	68 x 43 x 49	60 x 29 x 38		

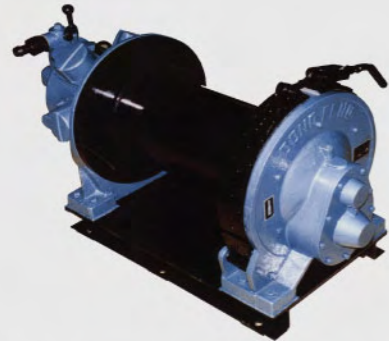

AIR WINCH (AW SERIES) (HT12) is designed under Ingersoll Rand BU7A and K6UL series.

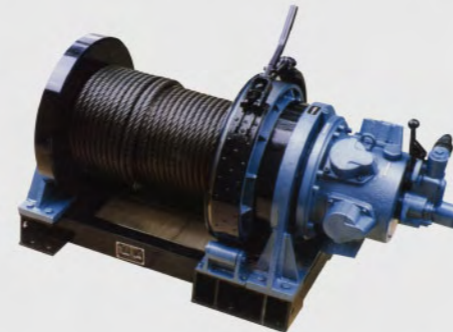

Model	AW0.5-I	AW0.5-II	AW1.0	AW1.0	AW3.0	AW5.0
Rated Load lb (kg)	1102 (500)	1102 (500)	2204 (1000)	2204 (1000)	6612 (3000)	11020 (5000)
Rope speed (m/m)	12	48	24	24	20	12
Size of rope (mm)	7.7	8	11	16	20	24
Length of rope (meter)	40	120	100	160	250	200
Air inlet size (mm)	15	25	25	38	38	38
Weight lb (kg)	104 (47)	258 (117)	357 (162)	970 (440)	1521 (690)	2535 (1150)

AIR SAFETY SPINNING WRENCH (SSW) (HT14) is designed and manufactured under Varco SSW-10 and SSW-40.

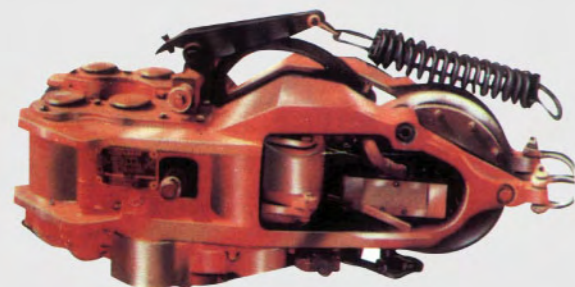

Safety Spinning Wrench is a pneumatically powered tool for spinning drill pipe, and drill collar up to 10 inch OD. Using the proven principle of frictional drive contact, the spinning wrench can spin drill pipe (drill collar) in or out quickly and efficiently without damage to expensive drill pipe and drill collar without the hazards of the dangerous spinning chain.

Model	Size of pipe (Inches)	Air pressure (PSI)	Rated power (HP)	Spinning Speed (RPM)	Spinning torque (lb-ft)	Braking Torque (lb-ft)
SSW10	3 1/2~ 5 1/2	72~130	12	90~56	465~738	929~1475
SSW40	3 1/2~10	72~130	16	108~38	403~922	806~1844

HYDRAULIC CATHEAD (HC) (HT16) is designed as associate tools to manual tong to breakout and make-up drill pipe.

Model	HC-17	HC-11	HC-8	HC-5
Rated pressure (psi)	2320	2320	2320	2320
Rated flow rate (GPM)	31.7	31.7	31.7	31.7
Pull strokes (inch)	64	65	55	67
Rated pull (US ton)	17.6	11.0	8.8	5.5



KELLY SPINNER (KS) (HT17) is designed and manufactured under Varco 6600 (Pneumatic Kelly Spinner) and 6800 (Hydraulic Kelly Spinner) designs, which is used for rotating drill pipe slowly, for limited rathole and mousehole drilling, and for making fast Kelly connections. This unit is completely reversible, the driller can spin out, as well as spin in, and when making connections, therefore, spinning chains are not required any more.

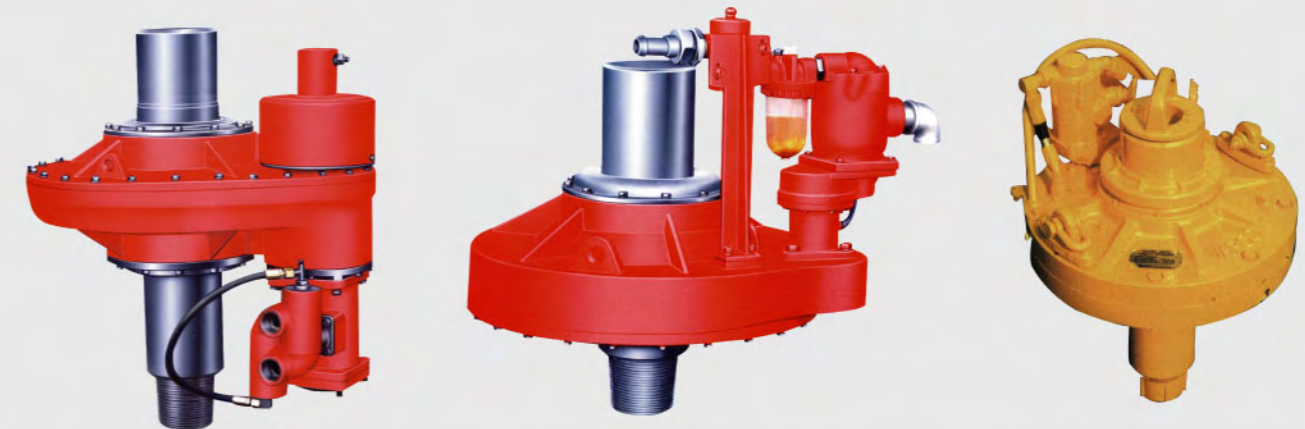

Model	KS800	KS1100	KS1200
Max. Static Load (US Ton)	250	250	250
Air pressure (PSI)	72~130	72~130	72~130
Rated Torque (lb-ft)	882	1180	1217
Stall Torque (lb-ft)	1200	1200	1200
Rated Speed (RPM)	76	72	72
Rotation	Right and Left	Right and Left	Right and Left
Stem connection	6 5/8" Reg L.H	6 5/8" Reg L.H	6 5/8" Reg L.H

International Tools designs A6C (Air-powered), A6H (Hydraulic-powered), B7 (Air-powered) and B7H (Hydraulic-powered) are also available for year 2007.

Complete line Blowout Preventer (BOP) and control system are available. API 16A

- Shaffer, Cameron designs BOP (Annular, Single Ram, Double Ram)
- Koomey designs Accumulator and Remote Control system.



21 1/4" x 2000 PSI

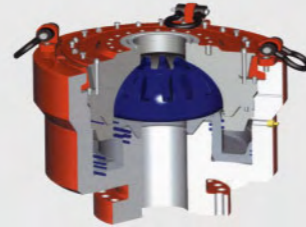

13 5/8" x 10000 PSI



13 5/8" X 5000 PSI



Double Ram



Single Ram



Single Ram

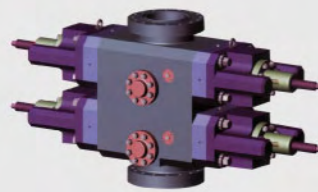

Double Ram



U type Single Ram



S Type Single Ram

RAM BOP(BOP02)

Working Pressure(PSI)	Bore Size (inch)				
	7 1/16	9	11	13 5/8	21 1/4
2000	--	--	--	--	✓
3000	✓	--	--	--	--
5000	✓	✓	✓	✓	--
10000	--	--	✓	✓	--
15000	--	--	--	✓	--

ANNULAR BOP(BOP01)

Working Pressure(PSI)	Bore Size (inch)				
	7 1/16	9	11	13 5/8	21 1/4
2000	--	--	--	--	✓
3000	✓	--	--	--	--
5000	✓	✓	✓	✓	--
10000	--	--	✓	✓	--
15000	--	--	--	✓	--



Shear /Blind Ram



Type F Ram



Type H Ram

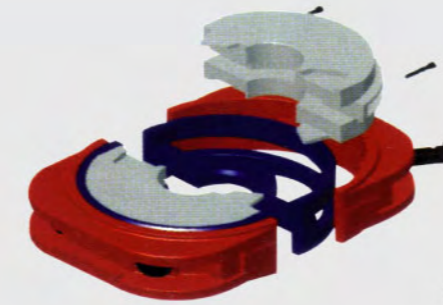

Type S Ram

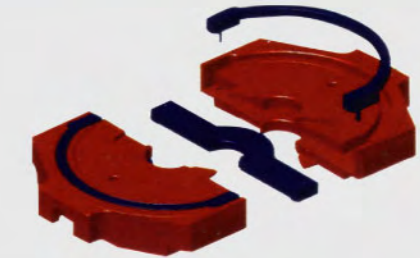

Type HF Ram

Ram Sizes

Working Pressure (PSI)	15000	10000		5000			3000	2000
Bore (in)	13 5/8	13 5/8	11	13 5/8	11	9	7 1/16	21 1/4
1 1/2							✓	✓
2 3/8	✓		✓				✓	
2 7/8	✓	✓	✓	✓	✓	✓	✓	
3 1/2	✓	✓	✓	✓	✓	✓		✓
4 1/2	✓	✓	✓	✓	✓	✓		
5	✓	✓	✓	✓	✓	✓		✓
5 1/2	✓	✓	✓	✓	✓	✓	✓	
7	✓	✓	✓	✓	✓			
9 5/8	✓	✓		✓				✓
13 3/8						✓		✓
Blind	✓	✓	✓	✓	✓		✓	✓
Variable Bore		✓		✓				
Shear /Blind	✓	✓						

ACCUMULATOR (BOP03)

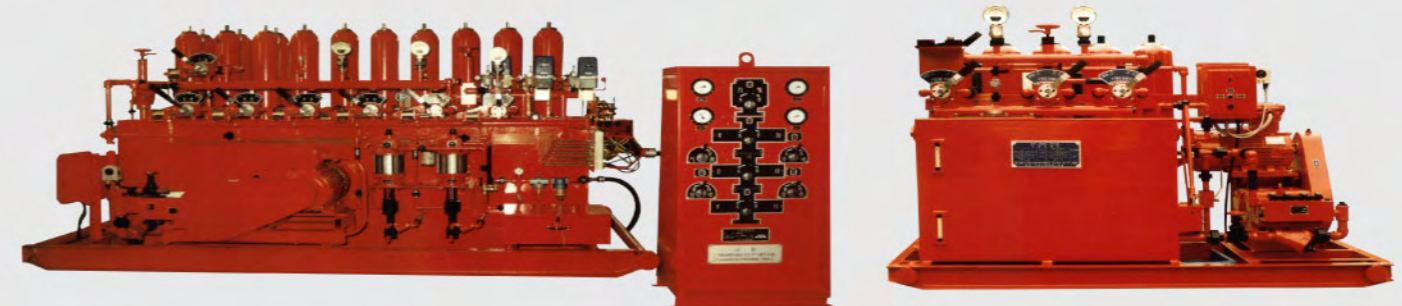

Model	Nos.of control	oil volume		Motor (HP)	Flow rate of pump			Working pressure (psi)
		Total volume (Gallon)	Effective volume (Gallon)		Electrical pump (GPM)	Air pump (GPS)	Manual pump (GPM)	
SC210-8	8	13 X 16	105	25 x 2	10 x 2	0.01 x 2		3000
SC185-8	8	13.2 X 14	92.5	25	10	0.01 x 2		3000
SC280-7	7	17.5 X 16	140	25 x 2	10 x 2	0.01 x 2		3000
SC176-7	7	8.8 X 20	88	25	10	0.01 x 2		3000
SC140-7	7	17.5 X 8	70	25	10	0.01 x 2		3000
SC176-6	6	8.8 X 20	88	25	10	0.01 x 2		3000
SC140-6	6	17.5 X 8	70	25	10	0.01 x 2		3000
SC105-5	5	17.5 X 6	52.5	25	7.5	0.01 x 2		3000
SC88-5	5	8.8 X 10	44	25	7.5	0.01 x 2		3000
SC70-4	4	8.8 X 8	35	20	6.8	0.01 x 1		3000
SC35-4	4	8.8 X 4	17.5	15	4.4	0.01 x 1		3000
SC52-4	4	8.8 X 6	26	15	4.4		0.003 x 2	3000
SC52-3	3	8.8 X 6	26	15	4.4		0.003 x 2	3000

ACCESSORIES TO ACCUMULATOR



QYB40-60L Air pump



JYS21-25 Regulating Valve



34ZS21-25 3-position 4-Way valve



KB16 Air H-P Testing Pump

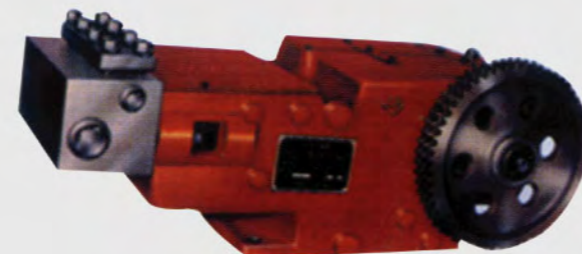

QB21-80 Tri-plunger pump

CHOKE AND KILL MANIFOLD SYSTEM (BOP04) API 16C

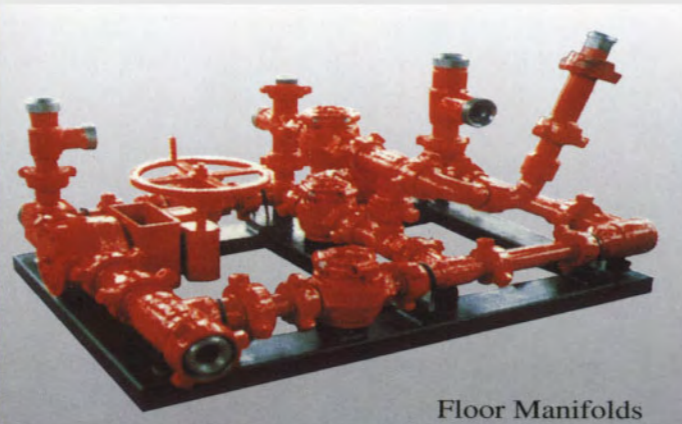

Floor Manifolds

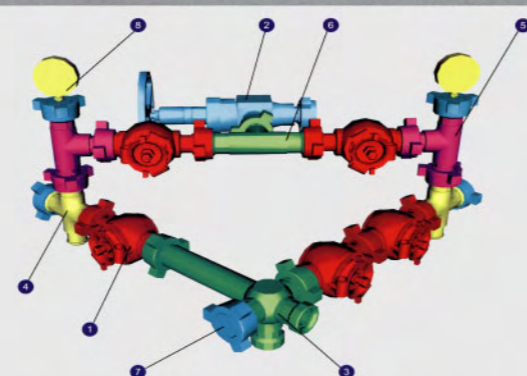
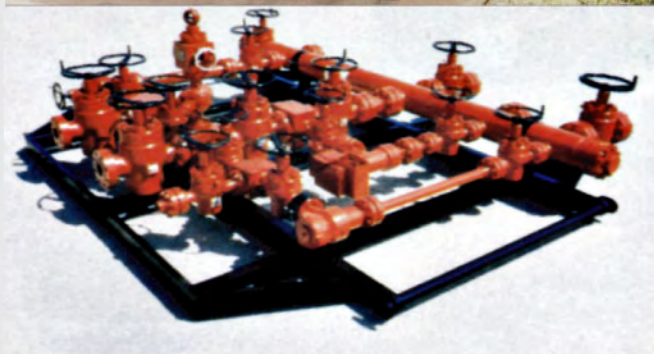

Choke and kill manifolds and its accessories are designed, machined and tested as per API 6A and API 16C Standards with the following features:

CHOKE VALVE(BOP07)

- No elastomer seals used in valves
- Shut-off pipelines at emergency by utilization of holed-disc choke valves.
- With pressure buffer tubes
- Sufficient thru-bore up to 4 1/16 inch.
- Working pressure up to 20,000 PSI
- Solid manifold available for offshore

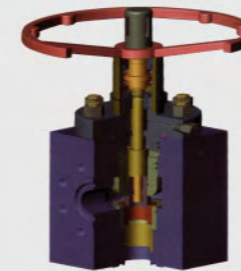

Adjustable Choke valve

Features:

- Convertibility: Positive Chokes can be converted readily to adjustable chokes by replacement of interchangeable bonnet and trims.
- Hardened stem and seat to withstand most erosive effects of highly abrasive materials
- Metal to metal seals between body and bonnet.
- Quick change connections for easy field maintenance

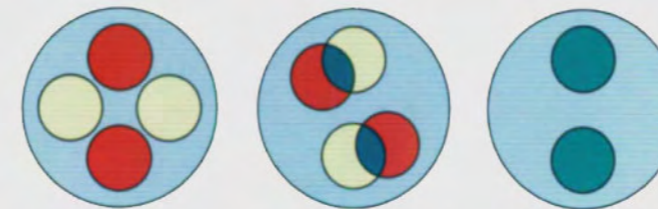

Holed-Disc type Choke valve

- Size: 1 thru 7 1/16"
- Working pressure up to 15,000 PSI
- Temp: -59°~ + 177°
- Trim: AA, BB, CC, DD, EE, FF, HH
- Operator: Manual, Hydraulic, Air, or electrical actuator

GATE VALVE (BOP08)

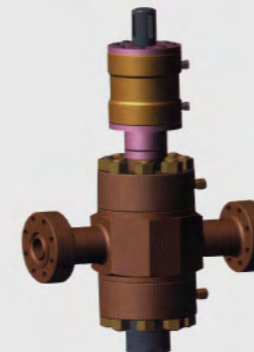

Hydraulic Gate valve without manual override

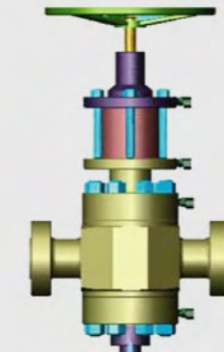

Hydraulic Gate valve with manual override

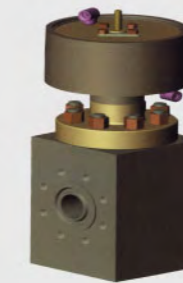

Hydraulic adjustable choke valve

Available

- Size 2 1/16" thru 4 1/16"
- Working Pressure: 3,000 thru 15,000 PSI- Temp: -60°C to 121°C (K, U)
- Trim: AA thru FF
- PSL: 3 thru 4
- PR: 1 thru 2

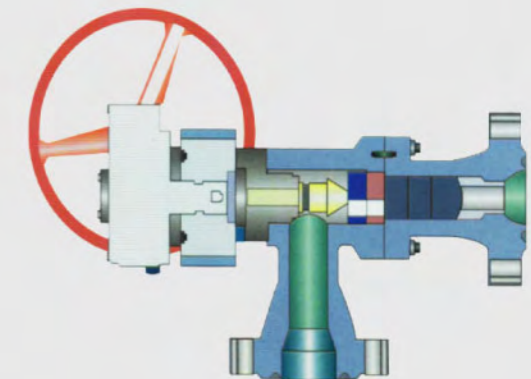

Features:

- Rising stem is pressure balanced by a tail rod to prevent a fluid lock from forming in valve cavity.
- Less than 1,500 PSI Hydraulic pressures will operate the valve, even under the most adverse conditions.
- Piston stops against cylinder head or bonnet, so there is never excessive stress in the stem or the gate.
- Handwheel operated manual override can be used to close the valve if hydraulic power is override lost, or to lock the valve in closed position. It cannot be used to open the valve.
- The manual override can be operated with full working pressure in the line and can be added or remove while the valve is in service

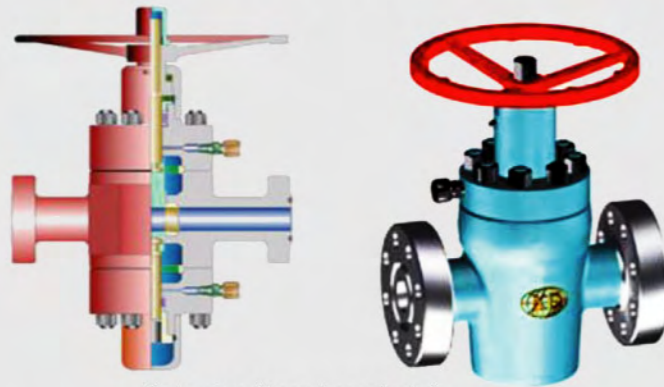

Gate valve (Manual or actuator)

Features:

- Forged body and bonnet
- Bi-directional design.
- Gate to seat, seat to body, bonnet seal and stem backseat are metal to metal sealing
- Pressure balancing stem significantly reduces operating torque
- Stem packing replaceable under full line pressure when valve is in closed position
- One piece gate
- Grease fitting in bonnet for easy lubrication

CHECK VALVE

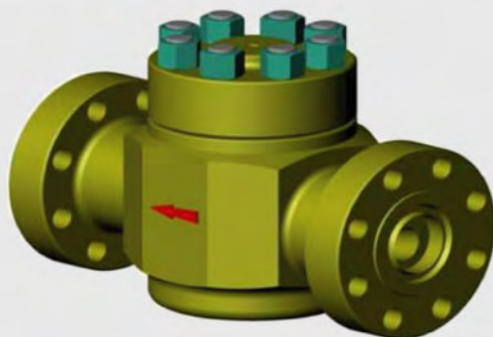

Features:

- Top entry for easy access to internal parts
- Long wearing internal parts available for regular and S.O.G service.
- Only three low cost internal parts which are easily replaced in the line
- Single directional check valve

Available

- Size: 2 1/16" thru 4 1/16"
- Working pressure: 3,000 PSI thru 20,000 PSI
- Temp: - 60°C to 121°C (K,U)
- Trim: AA thru FF- PSL: 1 thru 4
- PR: 1 thru 2

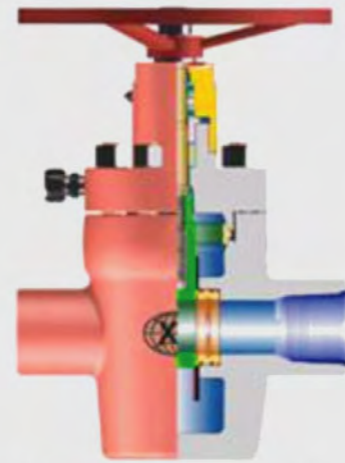

Gate valve (Manual or actuator)

Available

- Size: 2-1/16" thru 4-1/16"
- Working Pressure: 2,000 thru 5,000 psi
- Temp: - 60°C to 121°C (K,U)
- Trim: AA thru FF- PSL: 1 thru 4
- PR: 1 thru 2

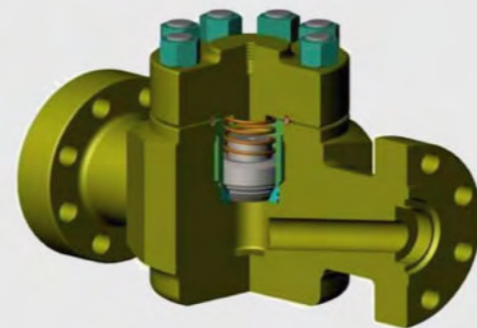

Available

- Size: 2-1/16" thru 4-1/16"
- Working Pressure: 2,000 thru 15,000 PSI
- Temp: - 60°C to 121°C (K, U)
- Trim: AA thru FF
- PSL: 3 thru 4
- PR: 1 thru 2

INSIDE BOP (BOP09)

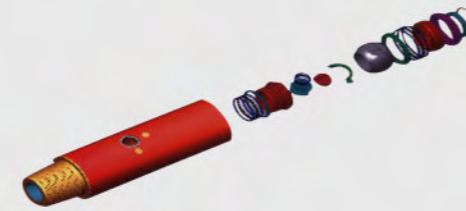

KELLY COCK (BOP0901)

OD: 4 3/4, 5 5/16, 6 5/8, 7, 7 1/4, 7 3/4, 8 inch.
The body is made of a single piece of forged AISI 4145 H modified alloy steel, full treated to 285-341 Brinell Hardness and 40 ft-lb

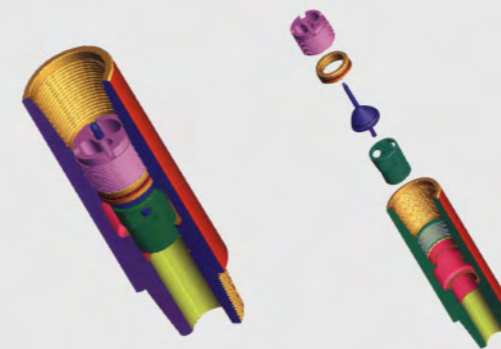

Arrow Type Check Valve (BOP0902)

is used to be installed between drill stem and bit to prevent drilling fluid backflow from the bottom.



FLOAT VALVE (BOP0903) is

installed in a standard bore-back of the bit sub, to provide fluid flow control at the bottom of the drill stem.



INSIDE BOP (BOP0904)

It is a heavy-duty drop check valve with up to 10,000-PSI WP.
OD 3 3/8 thru 9 1/2 inch

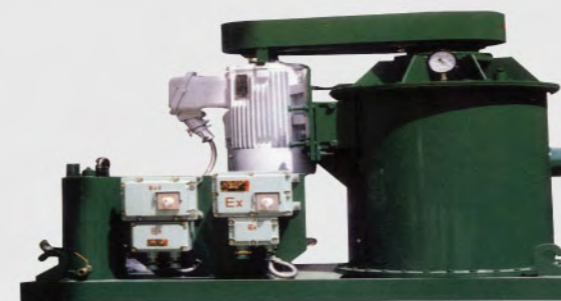

VACUUM DEGASSER (BOP11)

- Overall dimensions: 2.45m2.45m×6.85m
- Maximum working pressure: 1.5MPa (superior to foreign products of its same kind)
- Temperature for media:100°- Content of H2S gas inside the media:≤100ppm
- Volume: 6 m3
- Treatment capacity: 8000 m3/d



LIQUID-GAS SEPARATOR(BOP10)

- Treatment capacity: 4 m³/min
- Vacuum tightness: 400-530 mmHg
- Drive ratio: 1.67
- Vacuum pump power: 3KW
- Major electric motor power: 15KW
- Rotation speed: 876 r/min

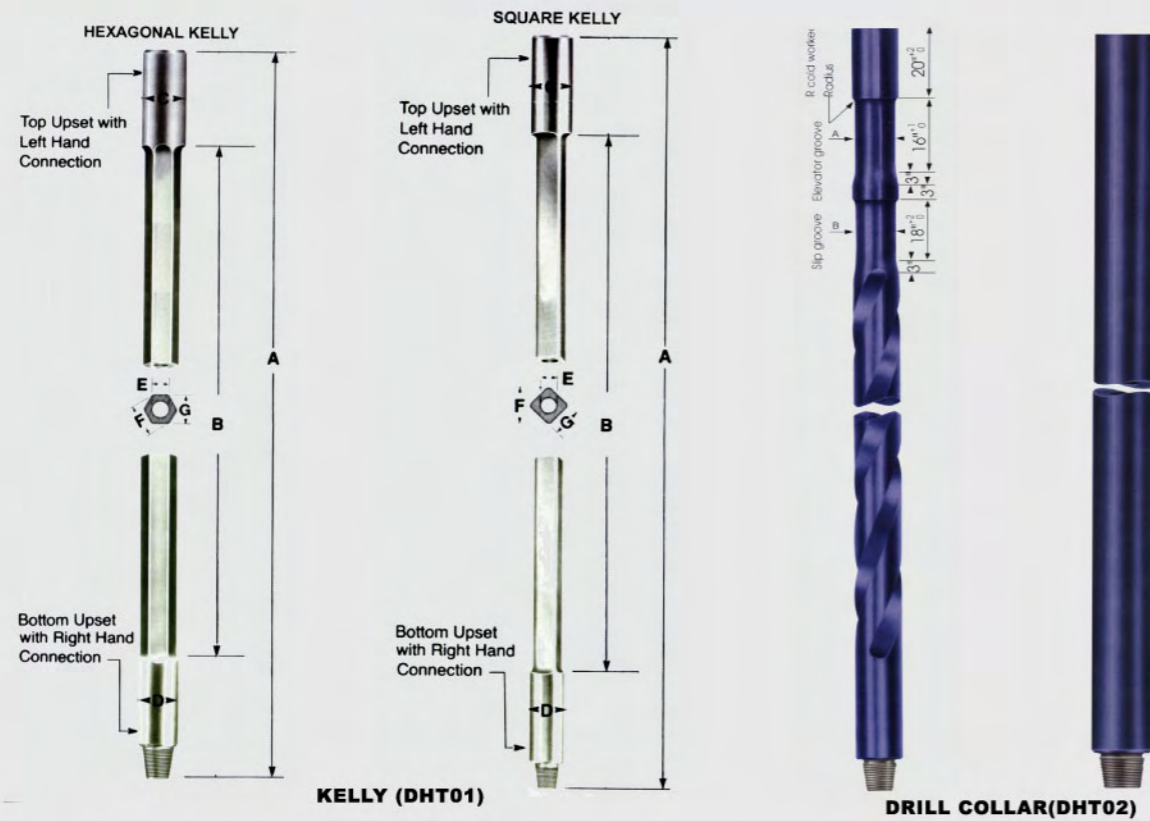

KELLY (DHT01)

DRILL COLLAR(DHT02)

STANDARD SIZE FOR SQUARE KELLY

Size (in)	Length (ft)		Top upset joint		Bottom upset		Bore E (in)	Drive Section		Weight (lb)
	A	B	LH	OD C (in)	RH	OD (in)		F (in)	G (in)	
2 1/2	40	37	6 5/8" Reg	7 3/4	2 3/8 IF	3 3/8	1 1/4	3 1/4	2 1/2	902
	46	43	6 5/8" Reg	7 3/4	2 3/8 IF	3 3/8	1 1/4	3 1/4	2 1/2	1023
3	40	37	6 5/8" Reg	7 3/4	2 7/8IF	4 1/8	1 3/4	3 7/8	3	1089
	46	43	6 5/8" Reg	7 3/4	2 7/8IF	4 1/8	1 3/4	3 7/8	3	1232
3 1/2	40	37	6 5/8" Reg	7 3/4	3 1/2IF	4 3/4	2 1/4	4 7/16	3 1/2	1320
	46	43	6 5/8" Reg	7 3/4	3 1/2IF	4 3/4	2 1/4	4 7/16	3 1/2	1474
	54	51	6 5/8" Reg	7 3/4	3 1/2IF	4 3/4	2 1/4	4 7/16	3 1/2	1716
4 1/4	40	37	6 5/8" Reg	7 3/4	4 IF	6	2 13/16	5 1/2	4 1/4	1815
	46	43	6 5/8" Reg	7 3/4	4 IF	6	2 13/16	5 1/2	4 1/4	2068
	54	51	6 5/8" Reg	7 3/4	4 IF	6	2 13/16	5 1/2	4 1/4	2354
5 1/4	40	37	6 5/8" Reg	7 3/4	NC50	7	3 1/4	6 7/8	5 1/4	2750
	46	43	6 5/8" Reg	7 3/4	NC50	7	3 1/4	6 7/8	5 1/4	3146
	54	51	6 5/8" Reg	7 3/4	NC50	7	3 1/4	6 7/8	5 1/4	3674
6	40	37	6 5/8" Reg	7 3/4	6 5/8 FH	8	3 1/2	7 5/8	6	3674
	46	43	6 5/8" Reg	7 3/4	6 5/8 FH	8	3 1/2	7 5/8	6	4224
	54	51	6 5/8" Reg	7 3/4	6 5/8 FH	8	3 1/2	7 5/8	6	4950

STANDARD SIZE FOR HEX KELLY

Size (in)	Length (ft)		Top upset joint		Bottom upset		Bore E (in)	Drive Section		Weight (lb)
	A	B	LH	OD C (in)	RH	OD (in)		F (in)	G (in)	
3	40	37	6 5/8" Reg	7 3/4	2 3/8IF	3 3/8	1 1/2	3 3/8	3	990
	46	43	6 5/8" Reg	7 3/4	2 3/8IF	3 3/8	1 1/2	3 3/8	3	1100
3 1/2	40	37	6 5/8" Reg	7 3/4	2 7/8IF	4 1/8	1 3/4	4 15/16	3 1/2	1276
	46	43	6 5/8" Reg	7 3/4	2 7/8IF	4 1/8	1 3/4	4 15/16	3 1/2	1474
	54	51	6 5/8" Reg	7 3/4	2 7/8IF	4 1/8	1 3/4	4 15/16	3 1/2	1716
4 1/4	40	37	6 5/8" Reg	7 3/4	3 1/2IF	4 3/4	2 1/4	4 25/32	4 1/4	1650
	46	43	6 5/8" Reg	7 3/4	3 1/2IF	4 3/4	2 1/4	4 25/32	4 1/4	1848
	54	51	6 5/8" Reg	7 3/4	3 1/2IF	4 3/4	2 1/4	4 25/32	4 1/4	2156
5 1/4	40	37	6 5/8" Reg	7 3/4	4 IF	6	2 13/16	5 29/32	5 1/4	2244
	46	43	6 5/8" Reg	7 3/4	4 IF	6	2 13/16	5 29/32	5 1/4	2574
	54	51	6 5/8" Reg	7 3/4	4 IF	6	2 13/16	5 29/32	5 1/4	2970
6	40	37	6 5/8" Reg	7 3/4	4 1/2IF	7	3 1/2	6 13/16	6	2904
	46	43	6 5/8" Reg	7 3/4	4 1/2IF	7	3 1/2	6 13/16	6	3300
	54	51	6 5/8" Reg	7 3/4	4 1/2IF	7	3 1/2	6 13/16	6	3894

DRILL COLLAR (DHT02)

The Drill Collars are made of AISI 4145 H or 4145 H Modified alloy steel. Its bore are trepanned from one direction with no mismatch. All drill collars are heat-treated with hardness within 285 to 341 BHN, which are guaranteed one inch below the surface of the pipe.

When order, pls specify:

- Type (slick or spiral grooved)
- Outside and inside diameters and overall length
- Connection size and type
- API Stress relief groove on pin and box ends
- Cast or pressed steel thread protectors
- Elevator recess or not
- Hard-banding or not
- Non-magnetic or not.

DATA SHEET FOR SLICK TYPE DRILL COLLAR

Size (in)	Bore (in)	Connection	Weight (lb)		Size (in)	Bore (in)	Connection	Connection	
			30 ft	31 ft				30 ft	31 ft
3 1/8	1 1/4	NC23	651.2	673.2	6 3/4	2 1/4	4IF	3132.8	3207.6
3 1/4	1 1/4	NC23	715	739.2	7	2 13/16	4 1/2IF	3258.2	3366
3 1/2	1 1/2	2 3/8IF	787.6	814	7 1/4	2 13/16	4 1/2IF	3535.4	3654.2
4 1/8	2	2 7/8IF	1031.8	1067	7 1/2	2 13/16	4 1/2IF	3830.2	3957.8
4 1/4	2	2 7/8IF	1119.8	1157.2	7 3/4	2 13/16	6 5/8 Reg	4129.4	4268
4 1/2	2	2 7/8IF	1287	1331	8	2 13/16	6 5/8 Reg	4439.6	4587
4 3/4	2 1/4	NC35	1383.8	1430	8 1/4	2 13/16	6 5/8 Reg	4769.6	4928
5	2 1/4	3 1/2IF	1575.2	1628	8 1/2	2 13/16	6 5/8 Reg	5093	5262.4
5 1/4	2 1/4	3 1/2IF	1784.2	1843.6	8 3/4	2 13/16	6 5/8 Reg	5440.6	5621
5 1/2	2 1/4	3 1/2IF	1991	2057	9	3	7 5/8 Reg	5695.8	5885
5 3/4	2 1/4	4FH	2219.8	2294.6	9 1/4	3	7 5/8 Reg	6067.6	6270
6	2 1/4	NC44	2450.8	2532.2	9 1/2	3	7 5/8 Reg	6430.6	6644
6 1/4	2 1/4	4IF	2692.8	2783	9 3/4	3	7 5/8 Reg	6815.6	7040
6 1/2	2 1/4	4IF	2948	3047	10	3	8 5/8 Reg	7207.2	7447

STABILIZER(DHT04)

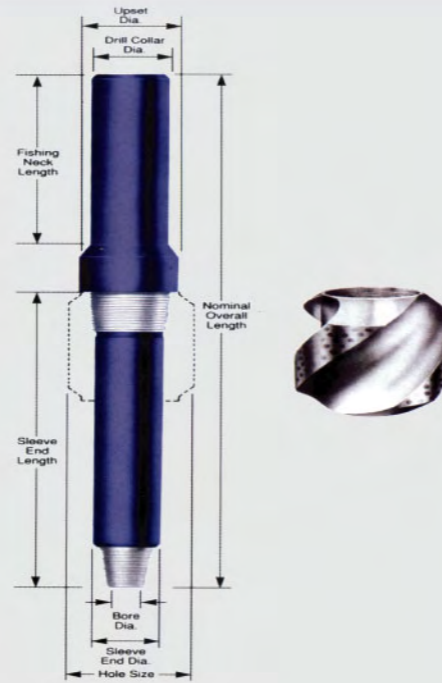
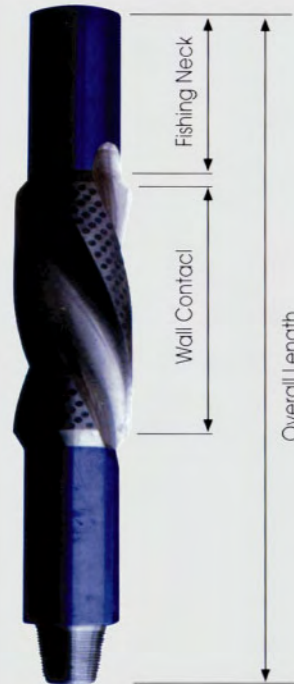

Integral spiral type

The Integral spiral stabilizers are made from AISI 4145 H Modified alloy steel or Non-magnetic alloy steel, the pressed button type or applied tungsten carbide hard faced on the blade.

Four designs are available as below:

- 1) Integral spiral stabilizer
- 2) Integral straight rib stabilizer
- 3) Interchangeable sleeve stabilizer

Sleeve type

- 1) Integral spiral stabilizer
- 2) Integral straight rib stabilizer
- 3) Interchangeable sleeve stabilizer
- 4) Sleeve stabilizer



Standard size of Integral spiral stabilizer

Hole Size (in)	Standard DC Size (in)	Wall Contact (in)	Blade width (in)	Fishing Neck length (in)	Blade under-gauge (in)	Overall length (in)		Weight (lb)
						String	Near Bit	
6-6 3/4	4 1/2-4 3/4	16	2 1/4	28	- 1/32	74	70	363
7 1/2-8 1/2	6 1/2	16	2 1/2	28	- 1/32	75	70	770
9 1/2-12 1/4	8	18	3 1/2	30	- 1/32	83	78	1650
14 3/4-17 1/2	9 1/2	18	4	30	- 1/32	92	87	2204
20-26	9 1/2	18	4	30	- 1/32	100	95	3960

Mechanical Properties for stabilizers					
OD	Tensile Strength (Mpa)	Yield strength (Mpa)	Elongation (%)	Reduction of area (%)	Impact (J)
4 3/4-6 1/4	≥965	≥ 758	≥ 13	40	≥54
7-9	≥ 931	≥ 689	≥ 13	40	≥54
Mechanical Properties for Sleeve					
	≥ 735	≥ 539	≥ 13	30	≥ 47

Hole size (in)	DC Size (in)	Upset Diameter (in)	Bottom Neck Dia. (in)	Overall length (in)	Fishing neck length (in)		Weight (lb)	Sleeve length (in)
					String	Near-Bit		
6 1/4-7 1/2	4 3/4-5	5 3/4	4 3/4	65	27	22	275	14
8 1/2-9 7/8	6 1/4-7 1/4	7 1/2	6 1/2	65	27	22	572	14
12 1/4-17 1/2	8 1/2-9	9 7/8	8 1/2	66	27	22	1012	18
14 3/4-20	9 1/2-10	11	9 5/8	66	27	22	1210	22

Interchangeable sleeve stabilizers are made of 4145 H Alloy steel, heat-treated to 285-341 Brinell Hardness and 54 Joules minimum impact value. All physical properties would be guaranteed 1" under the surface. The stabilizer is constructed of two pieces, which are jointed, by the center mandrel and one sleeve.



Hole size (in)	Sleeve		DC Size (in)	Bore (in)	Upset Dia. (in)	Center connection	Weight (lb)	Overall length (in)
	Blade width (in)	Length (in)						
6 1/8	2	18	4 1/8	2	4 3/4	2 7/8IF	275	64
6 1/4-6 3/4	2	18	4 3/4	2	4 3/4	2 7/8IF	275	64
7 3/8-7 3/4	2	18	5 3/4	2 1/4	5 3/4	3 1/2IF	396	66
8 1/2-8 3/4	2 3/8	18	6 1/2	2 13/16	6 3/4	4IF	550	68
9 1/2-11	2 3/4	18	7 1/4	2 13/16	7 1/2	4 1/2IF	726	68
12 1/4-17 1/2	3 1/8	24	9 1/2	3	9 1/2	7 5/8 Reg	1210	81
17 1/2-20	4	33	11 1/4	3	11 1/4	8 5/8 Reg	1782	90
22-26	4	33	9 1/2	3	9 1/4	7 5/8 Reg	1353	90

DOWN HOLE MOTOR (DHM) (DHT05)

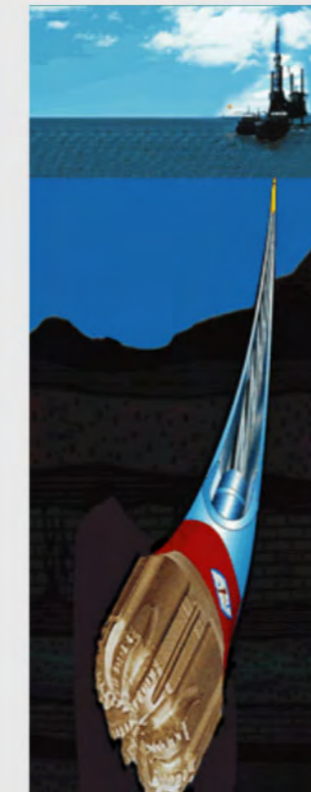

Motor OD (in)	No. of lobes	No. of Stages	RPM	Torque (ft-lb)
2 7/8	5:6	3	100-260	690
	7:8	4	180-380	1,000
3 1/8	7:8	4	180-380	1,000
3 1/2	5:6	3	100-240	960
3 3/4	1:2	4	200-550	650
	5:6	3	100-260	1,300
4 3/4	9:10	4	60-150	1,600
	5:6	3	70-175	2,100
	5:6	4	70-175	2,800
	5:6	5	70-175	3,500
	5:6	6	70-175	4,200
	5:6	3	40-150	2,800
6 1/2	5:6	4	75-180	4,900
	5:6	5	75-180	6,600
	5:6	6	75-180	6,900
6 3/4	9:10	4	55-180	10,900
	5:6	4	80-180	5,500
	5:6	5	80-180	6,700
	5:6	6	80-180	7,800
7 3/4	9:10	2	55-180	7,500
	5:6	4	55-180	12,400
	5:6	4	75-150	8,500
	5:6	5	75-150	10,500
8 1/2	5:6	6	75-150	12,500
	5:6	4	75-180	11,700
	5:6	5	75-180	14,500
	5:6	6	75-180	17,300
9 5/8	3:4	6	100-250	21,800
	5:6	4	75-185	16,200
	5:6	5	75-185	16,900
	5:6	6	75-185	17,100



Optional tools.

Lift sub	Orienting sub	Adjustable bend housing (0-3 /0-4 degree)
Float sub	Safety sub	Lower integral stabilizer
Dump valve	Upper stabilizer	Lower changeable stabilizer

HOLE OPENER (DHT06)

BZ Fixed Diameters hole openers are made of tough treaded allow steel for maximum strength. Cutter arms are hard faced and welded on body, equipped with removable cutters. Cutters are available in three types.

- Type SM is for soft to medium formations.
- Type MH for medium to hard formation
- Type XH for hard formation.

The hole openers have three or six jet tubes with replaceable nozzles, so that jets streams quickly clean the enlarged hole.

Hole Size (inch)	Number of Cutters	Pilot Hole (min)	Fishing Neck (in)			Bottom	Bore (inch)	Overall Length (inch)	Weight w/cutters (kg)
			Length	Dia	Top Conn.				
17 1/2	3	10-1/2"	18"	9-1/2"	7 5/8 Reg.	7 5/8 Reg	2 1/4	59	550
26"	3	17 1/2"	18"	10"	7 5/8 Reg.	7 5/8 Reg	3	69	900
36"	3	24"	20"	9"	7 5/8 Reg.	7 5/8 Reg	3	75	1000
	4	18"	43"	10"	7 5/8 Reg.	7 5/8 Reg	3	100	1540

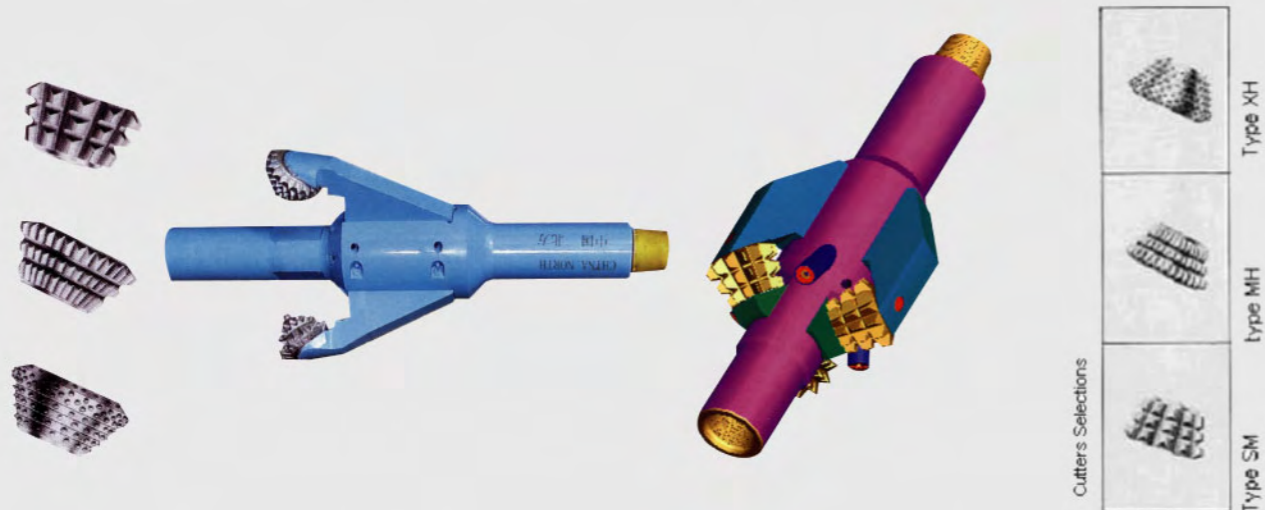

REAMER (DHT07)

The rotary reamer is designed for every reaming operation but particularly for stabilization purposes when drilling in very abrasive formations. This is a versatile tool. It will fit hole sizes ranging from 4-5/8" to 26". In addition, each body, by simple adjustment of blocks and proper selection of cutters, will suit a wide range of hole sizes.



Its body is made of modified alloy steel, fully heat treated to 285-341 Brinell hardness and 54J minimum impact strength. Connections are cold rolled, phosphated, coated and equipped with protectors and are gagged to API Standards. Its body is inspected on an ultrasonic control unit over its full length and section. The original cutter and block assembly allows easy replacement of cutters by rig crews.

Hole Size	Connection	OD mm	Overall length mm	Neck OD mm
26"	7-5/8REG	660.4	3000	254
26"	7-5/8H90	660.4	3000	254
17-1/2#	7-5/8REG	444.5	2200	228
12-1/4#	6-5/8REG	311.2	2000/2127	228
9-5/8#	5-1/2FH	244	1800	178
8-1/2#	4-1/2REG	215.9	1730/1844.	165
8-3/8#	4-1/2REG	212.7	1600	165
8-1/8#	4IF	209	1600	165
6-1/8#	3-1/2IF	155	1470	140
6"	3-1/2IF	152	1400	121
5-7/8#	3-1/2IF	149	1470	121

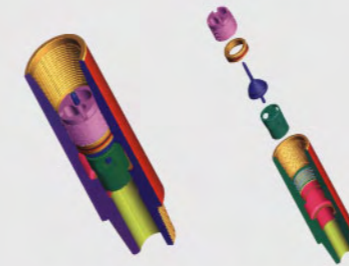

FLOATING VALVE (DHT10)



X-OVER SUBS (DHT11)

